

Concurrent Implementation of Skip Trees

Vladimir Magdin
Feb 7 2011

Introduction

topic: alternate balanced tree data structure

outline: balanced search trees

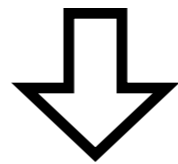

skip lists

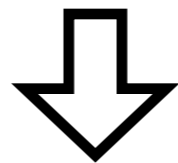

skip trees

Balanced Search Trees

- can represent ordered sets and dictionaries
- $O(\log(n))$ for search, insert, delete operations
- two major types:
 - rotations of nodes (e.g. AVL tree)
 - splitting/merging of nodes (e.g. B-tree)

Balanced Search Trees

disadvantages

- rotations are complicated
 - implementation
 - constant factor: $O(c \log(n))$
- order of insertions might matter

Node Level Selection

- fraction p (e.g. $1/2$) of the nodes at level(i) also have pointers at level($i+1$)

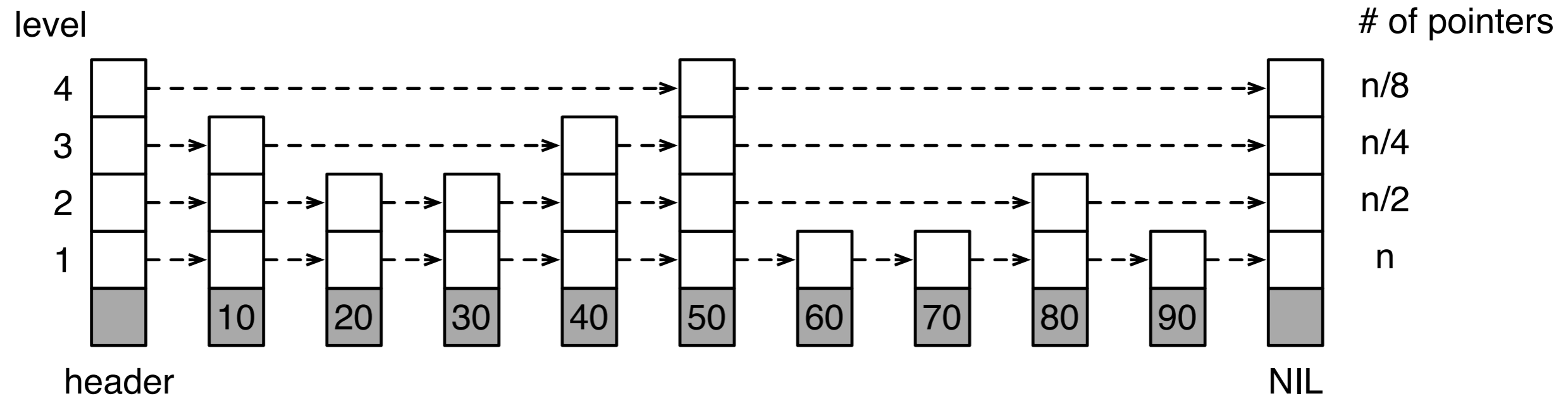

Node Level Selection

- drawing level from the negative binomial distribution

NB(1,p) leads to $O(\log_{1/p}(n))$ search

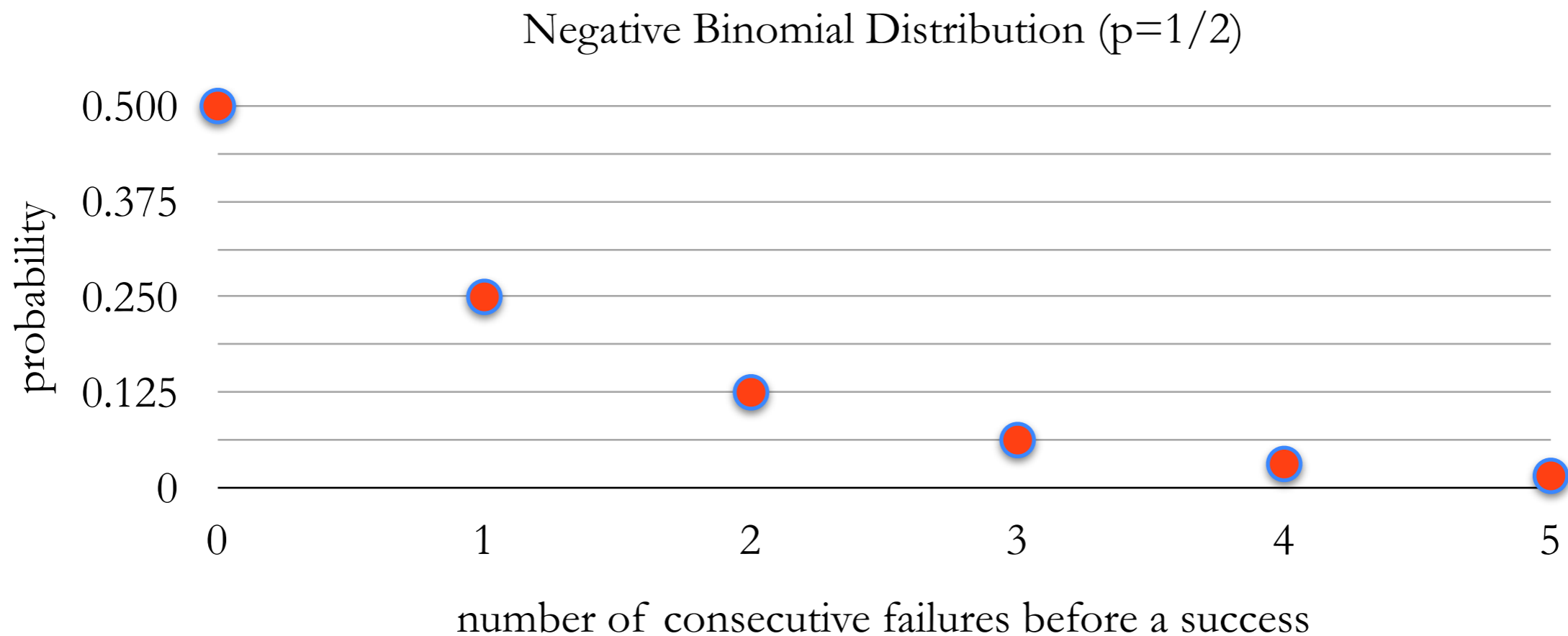

Skip List - Insertion

insert: 85

level

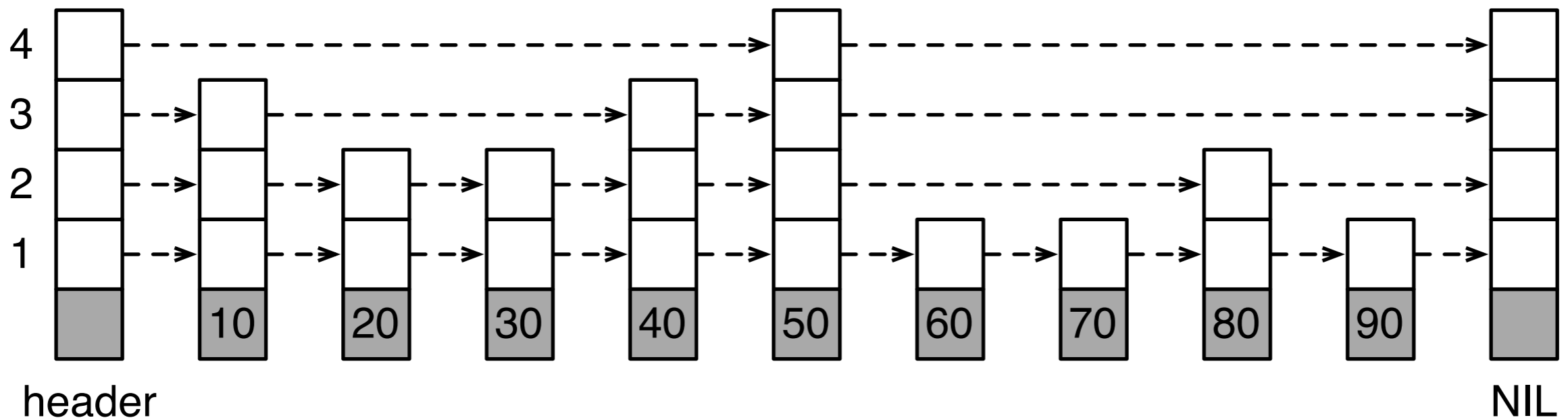

Skip List - Insertion

insert: 85

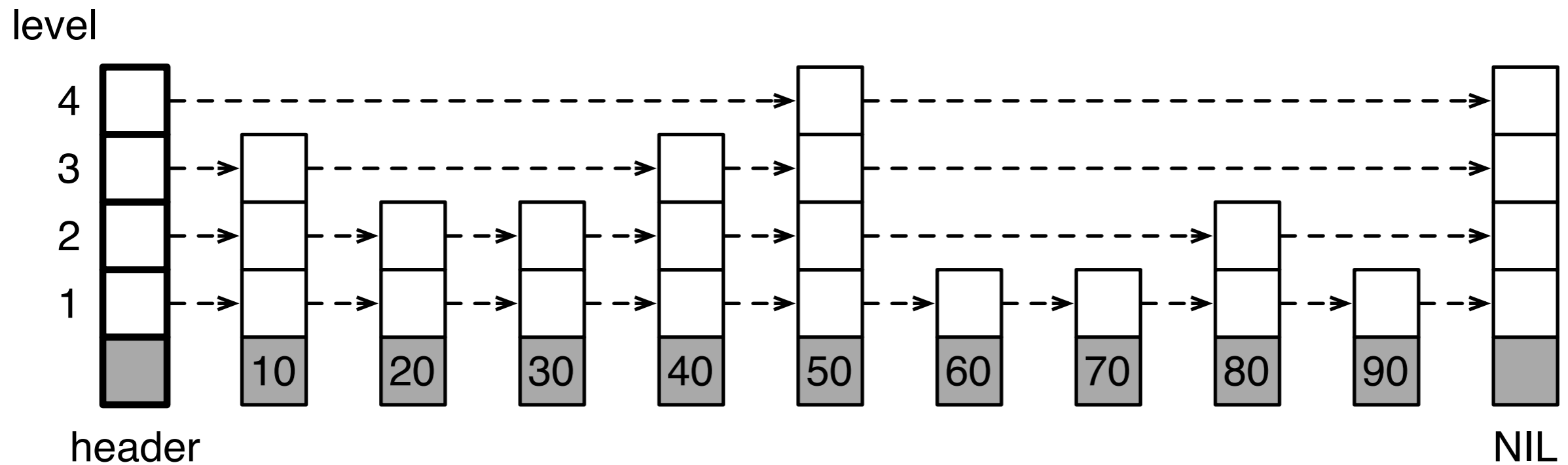

Skip List - Insertion

insert: 85

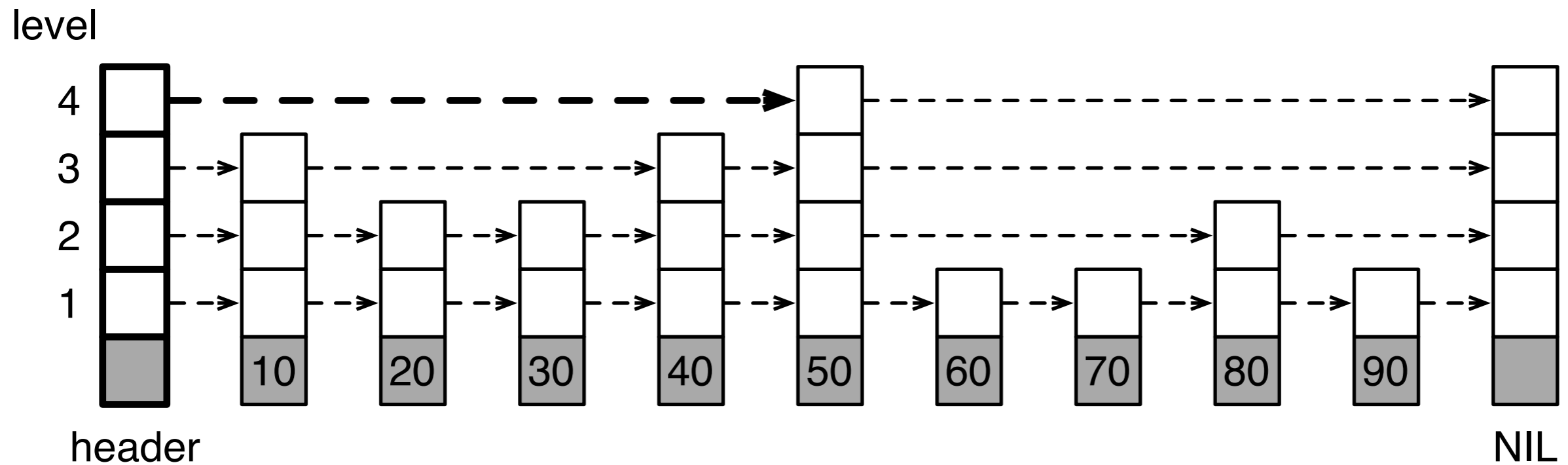

Skip List - Insertion

insert: 85

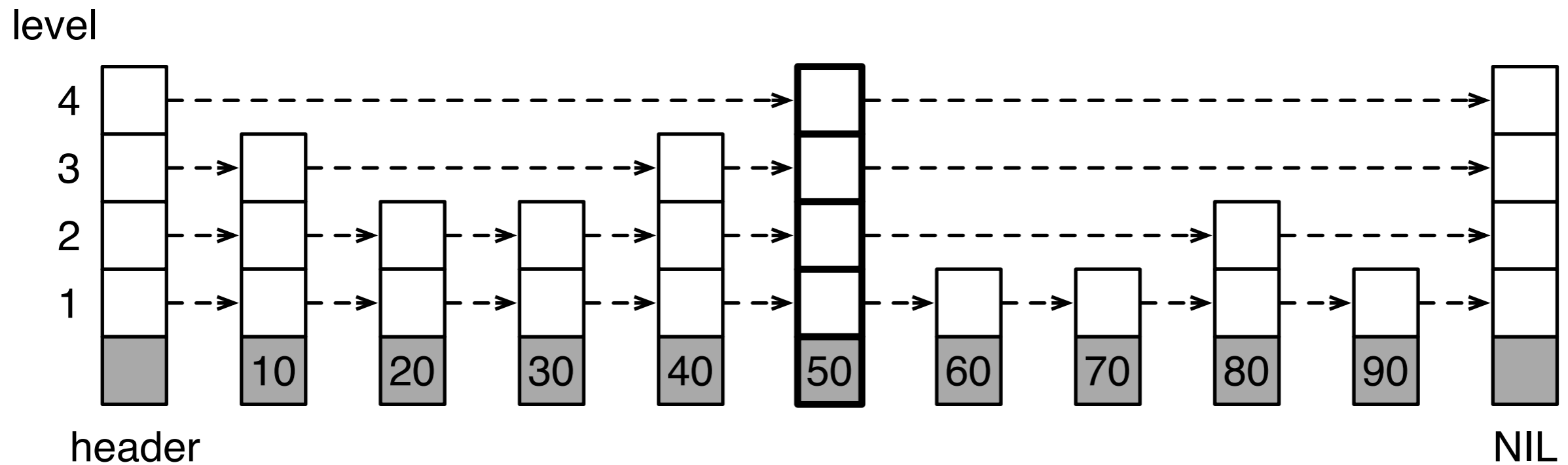

Skip List - Insertion

insert: 85

level

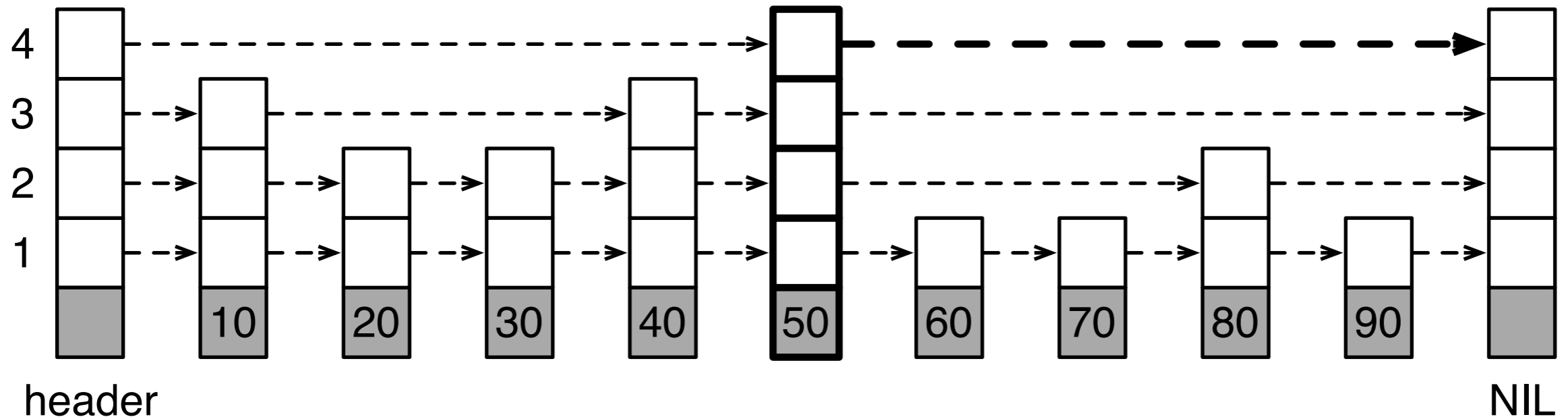

Skip List - Insertion

insert: 85

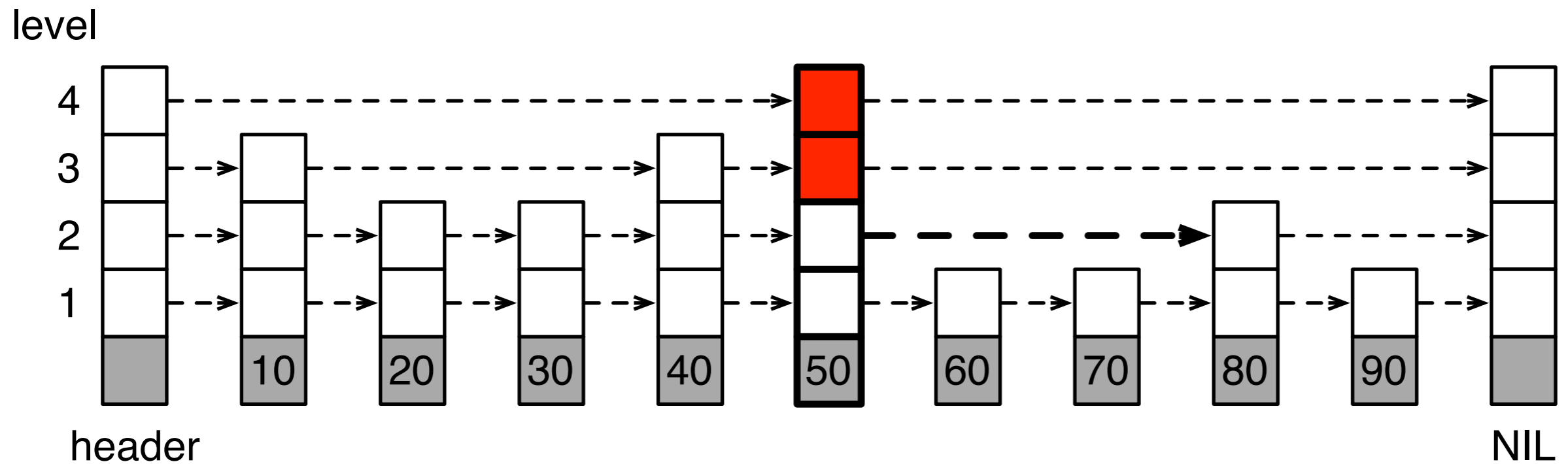

Skip List - Insertion

insert: 85

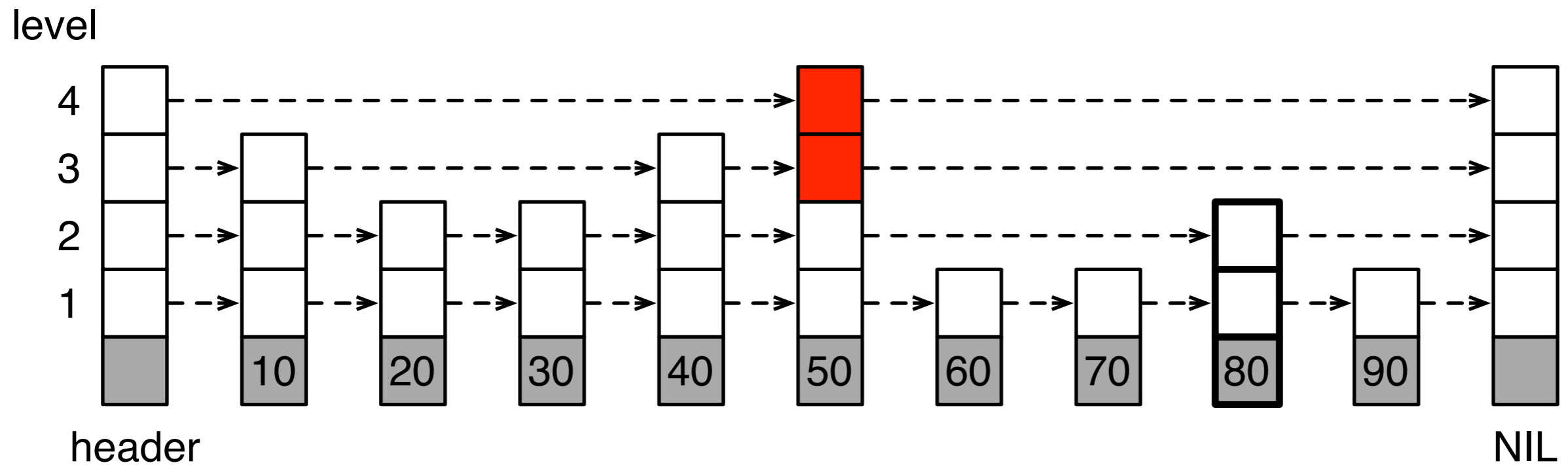

Skip List - Insertion

insert: 85

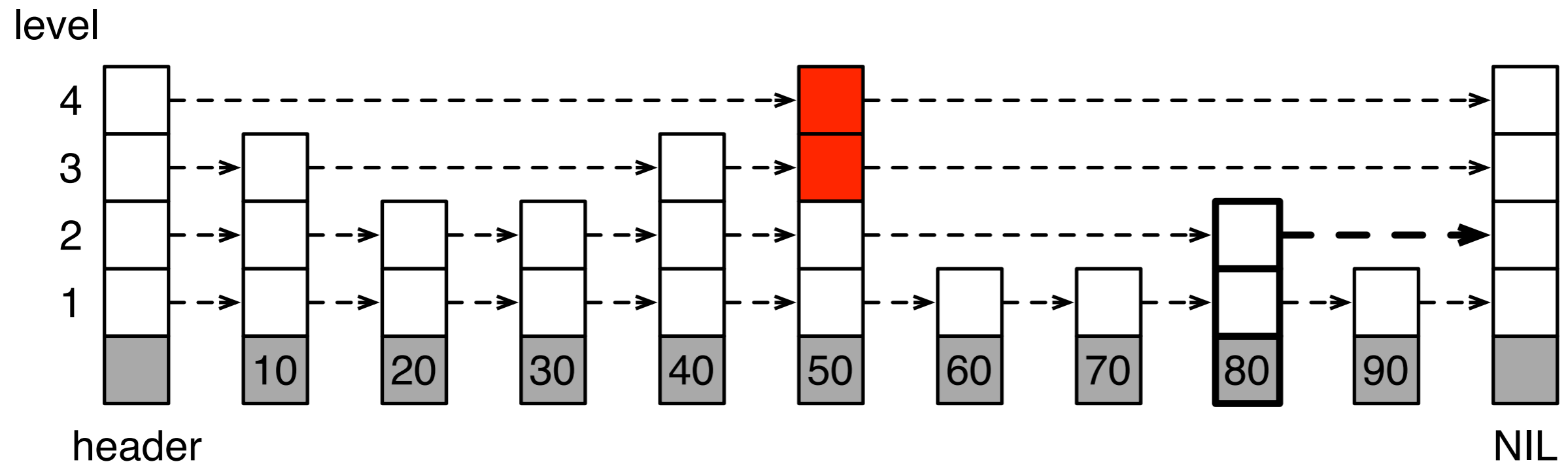

Skip List - Insertion

insert: 85

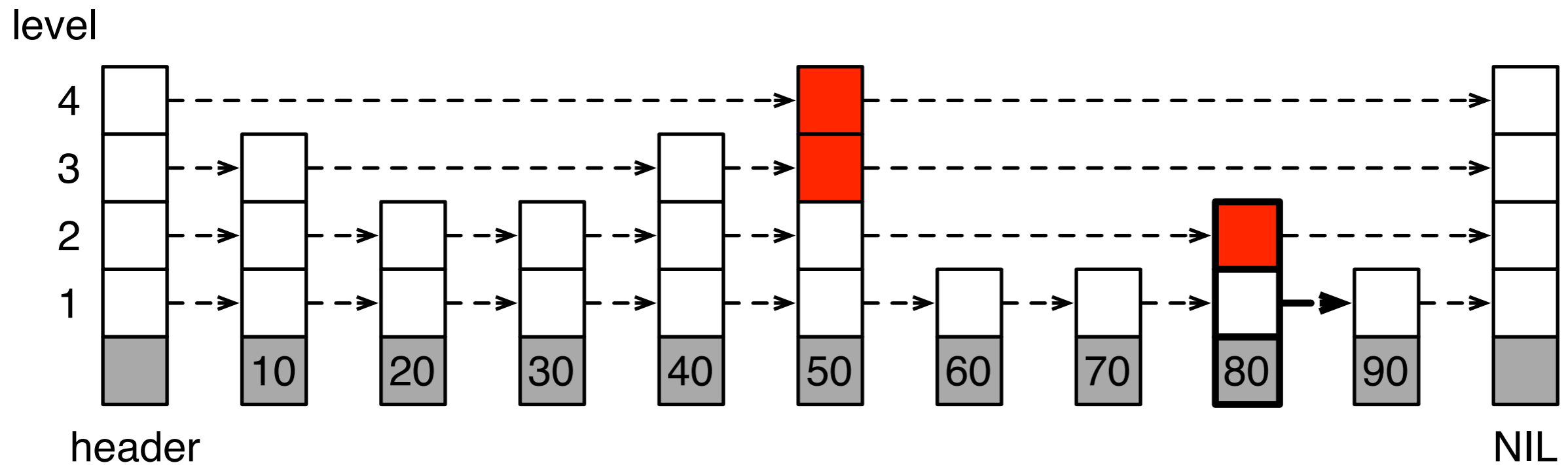

Skip List - Insertion

insert: 85

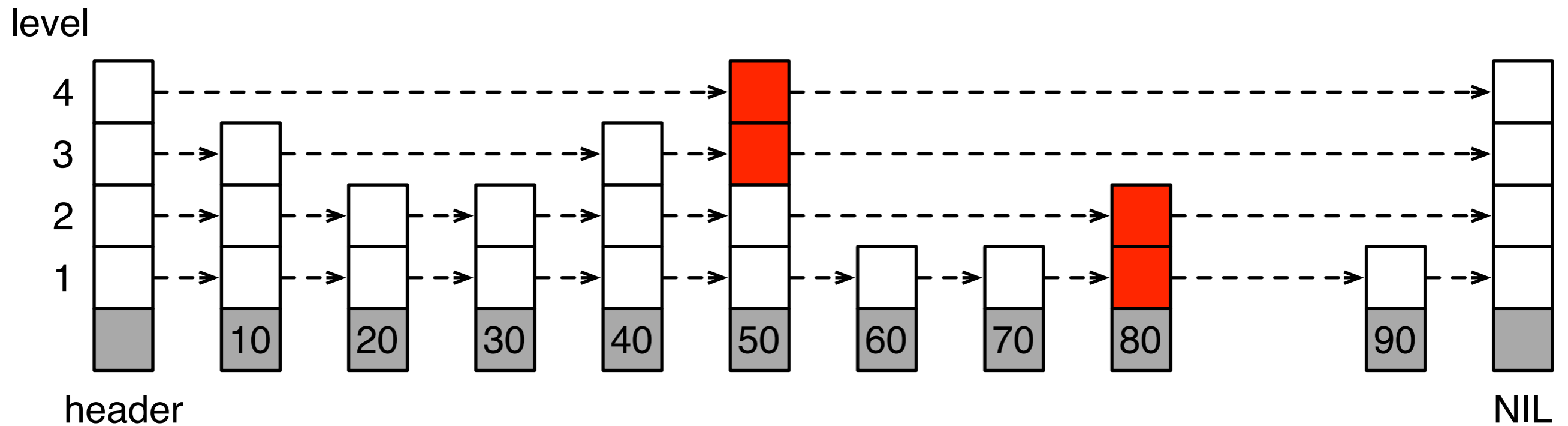

Skip List - Insertion

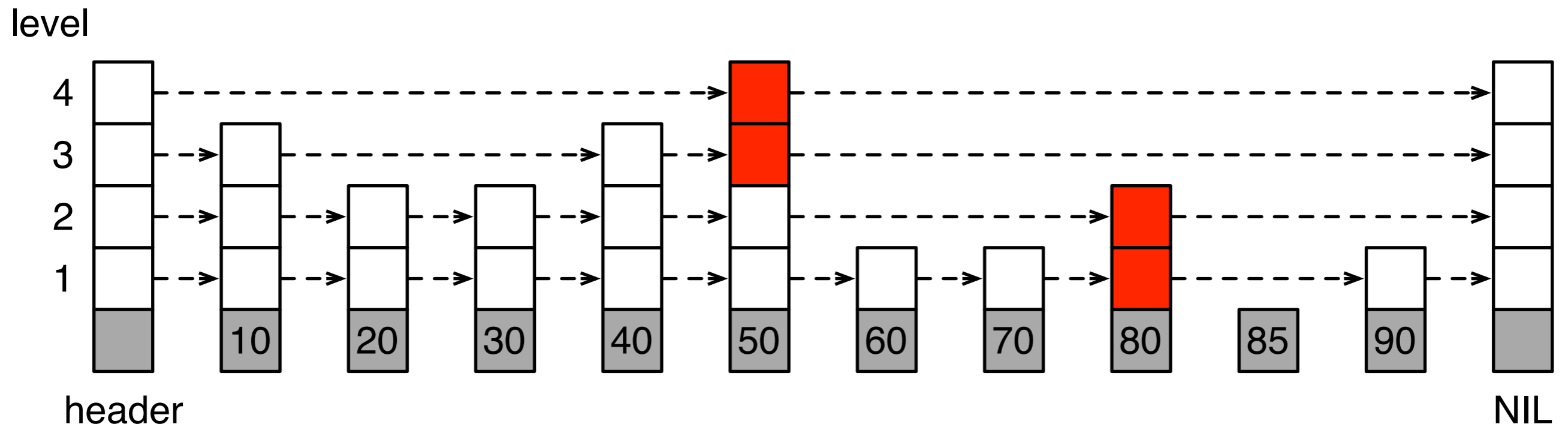

Skip List - Insertion

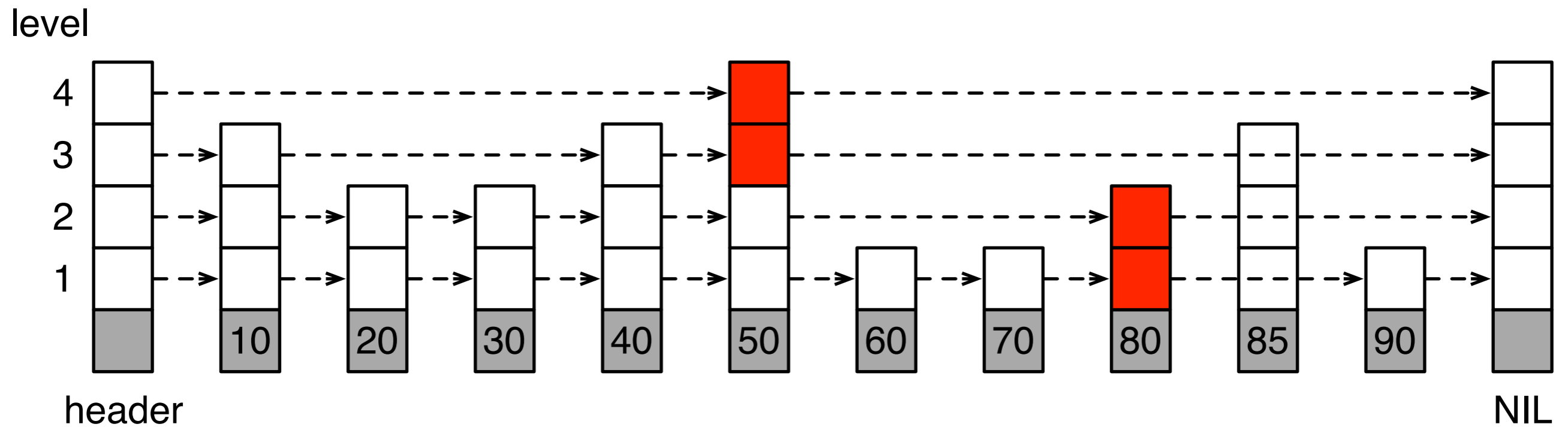

Skip List - Insertion

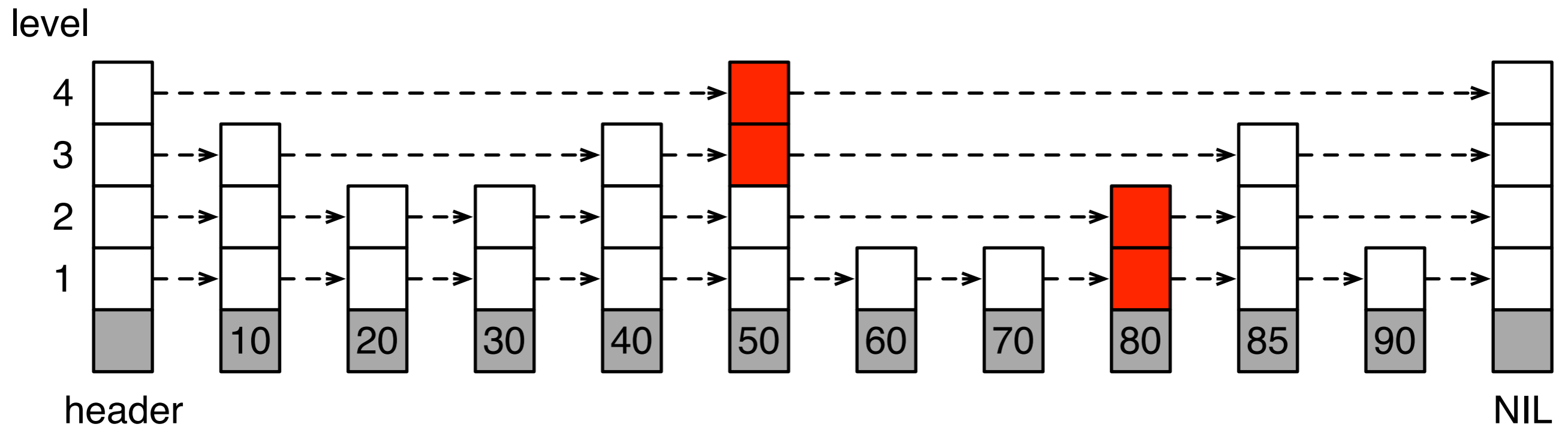

Skip List - Insertion

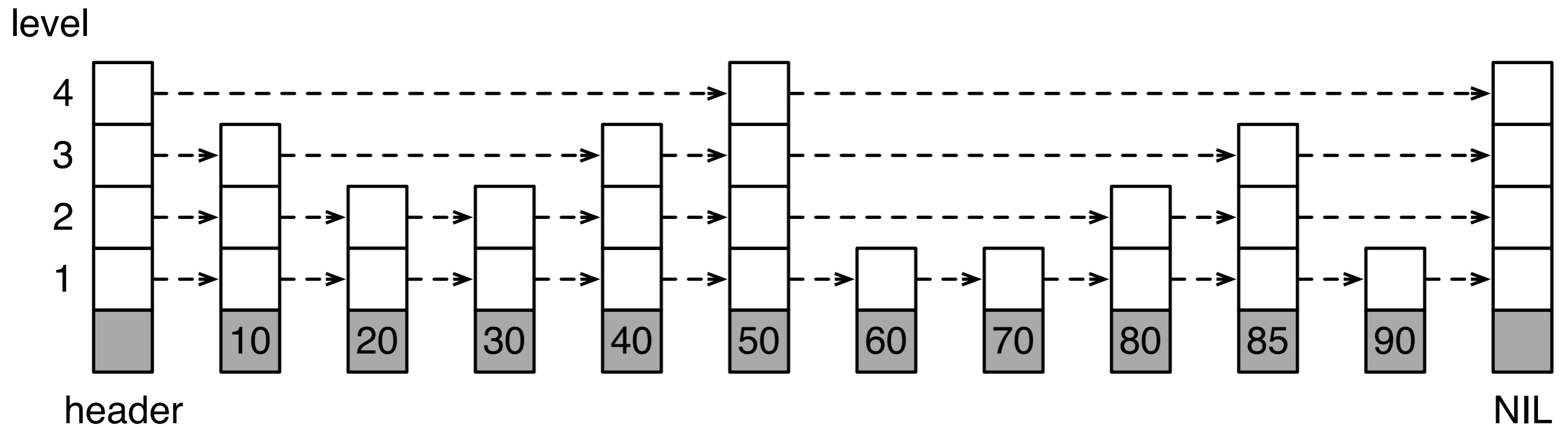

Skip Lists

ADVANTAGES

- order of insertion does not matter
- easy to implement
- constant factor performance advantage over trees
- space efficient

DISADVANTAGES

- cannot be paginated efficiently
- insertion/deletion requires global search

skip list

level

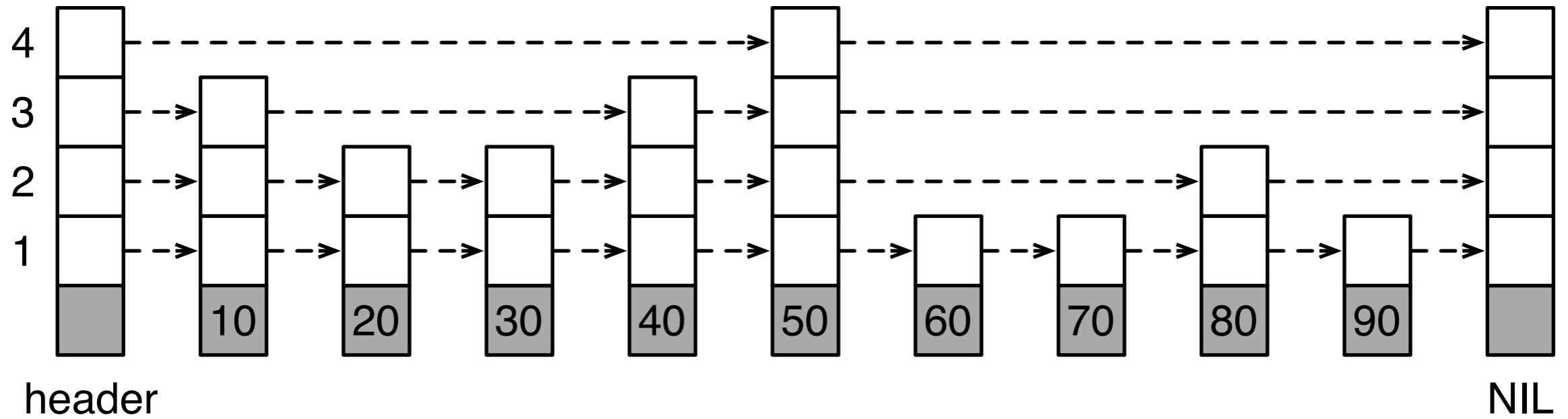

skip lists can be re-envisioned as trees
(Xavier Messeguer, 1997)

skip list

level

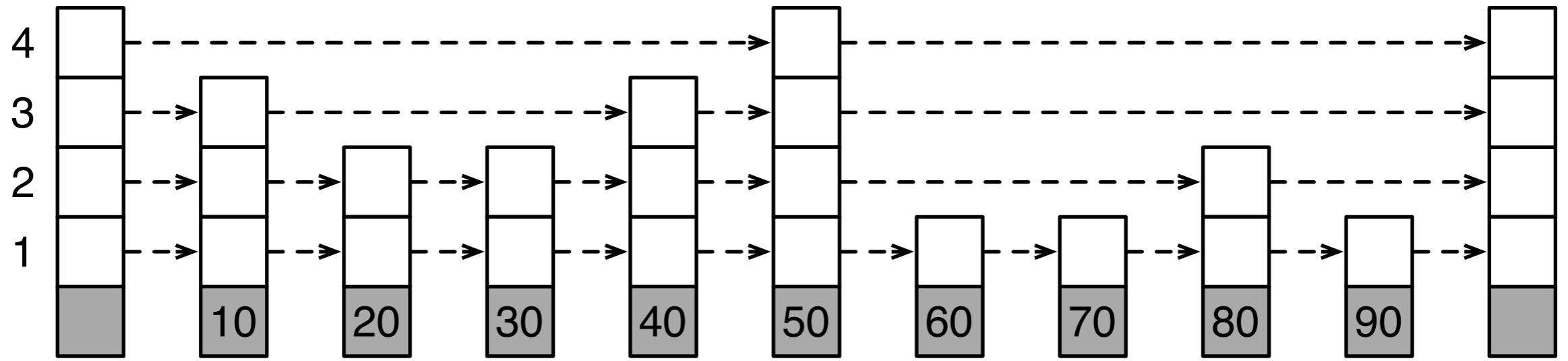

header

NIL

skip tree

Level

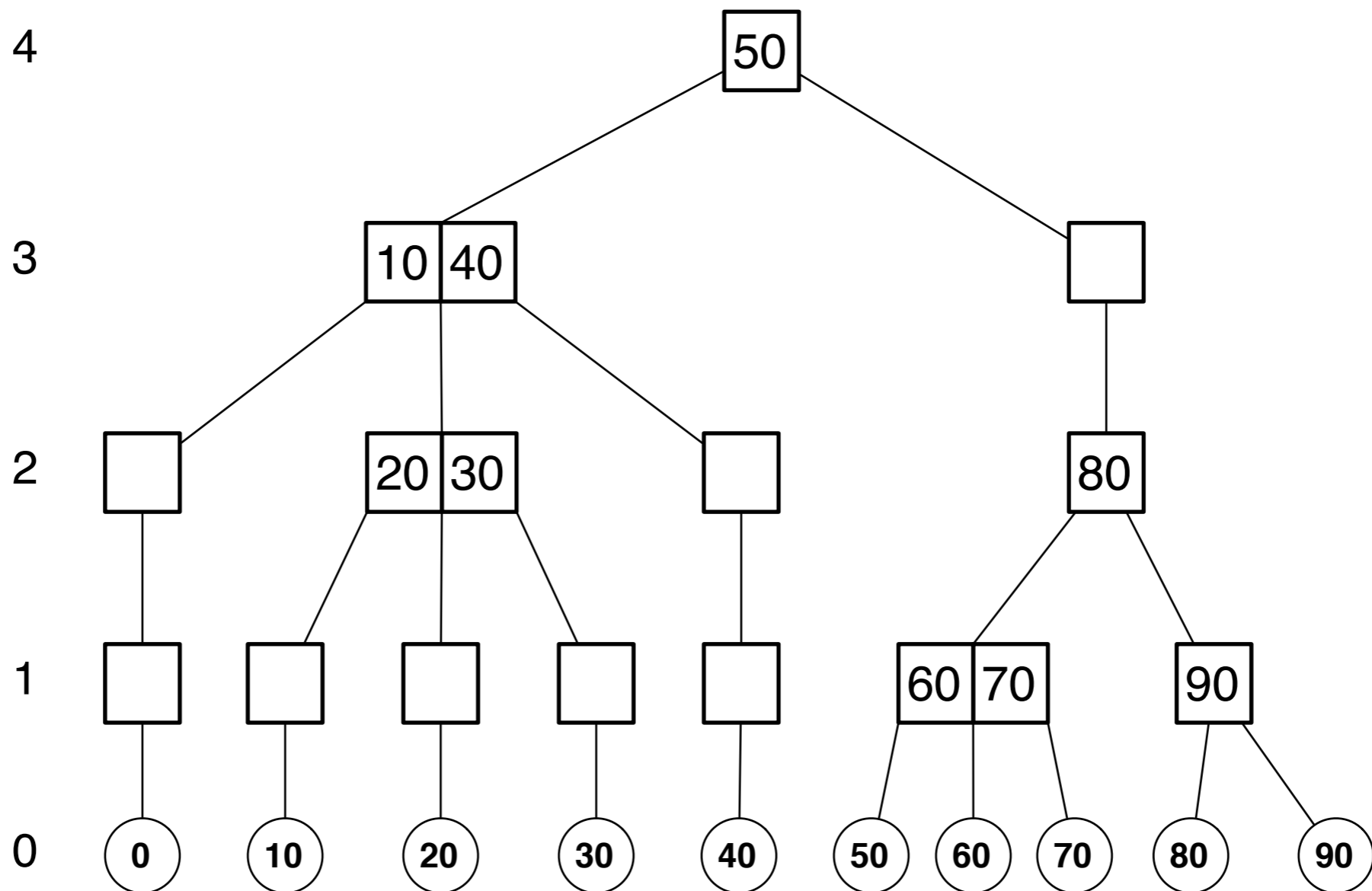

skip list

level

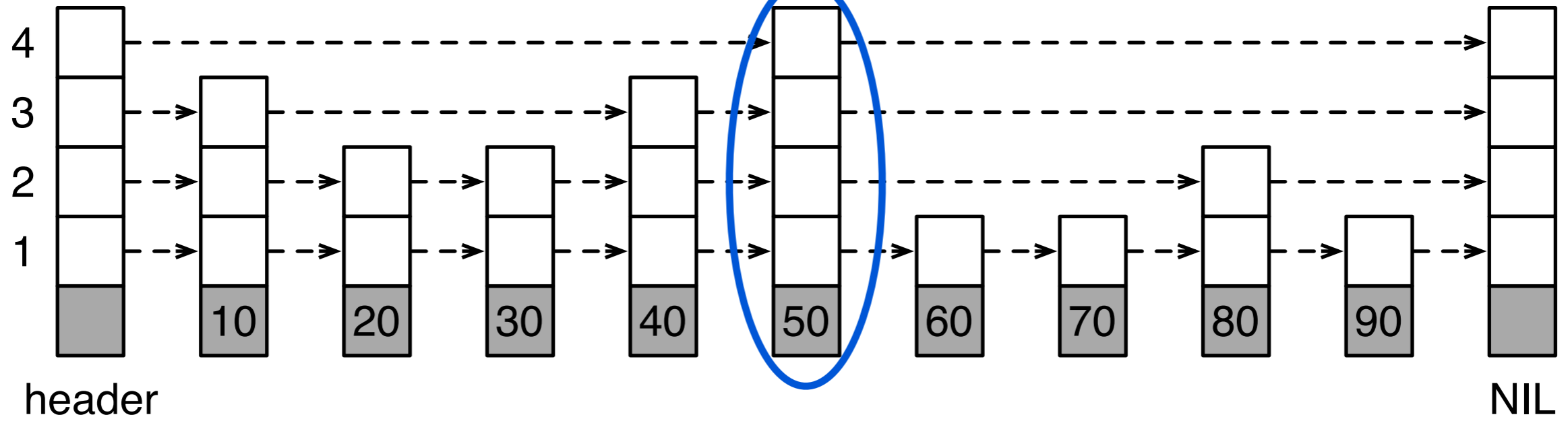

skip tree

Level

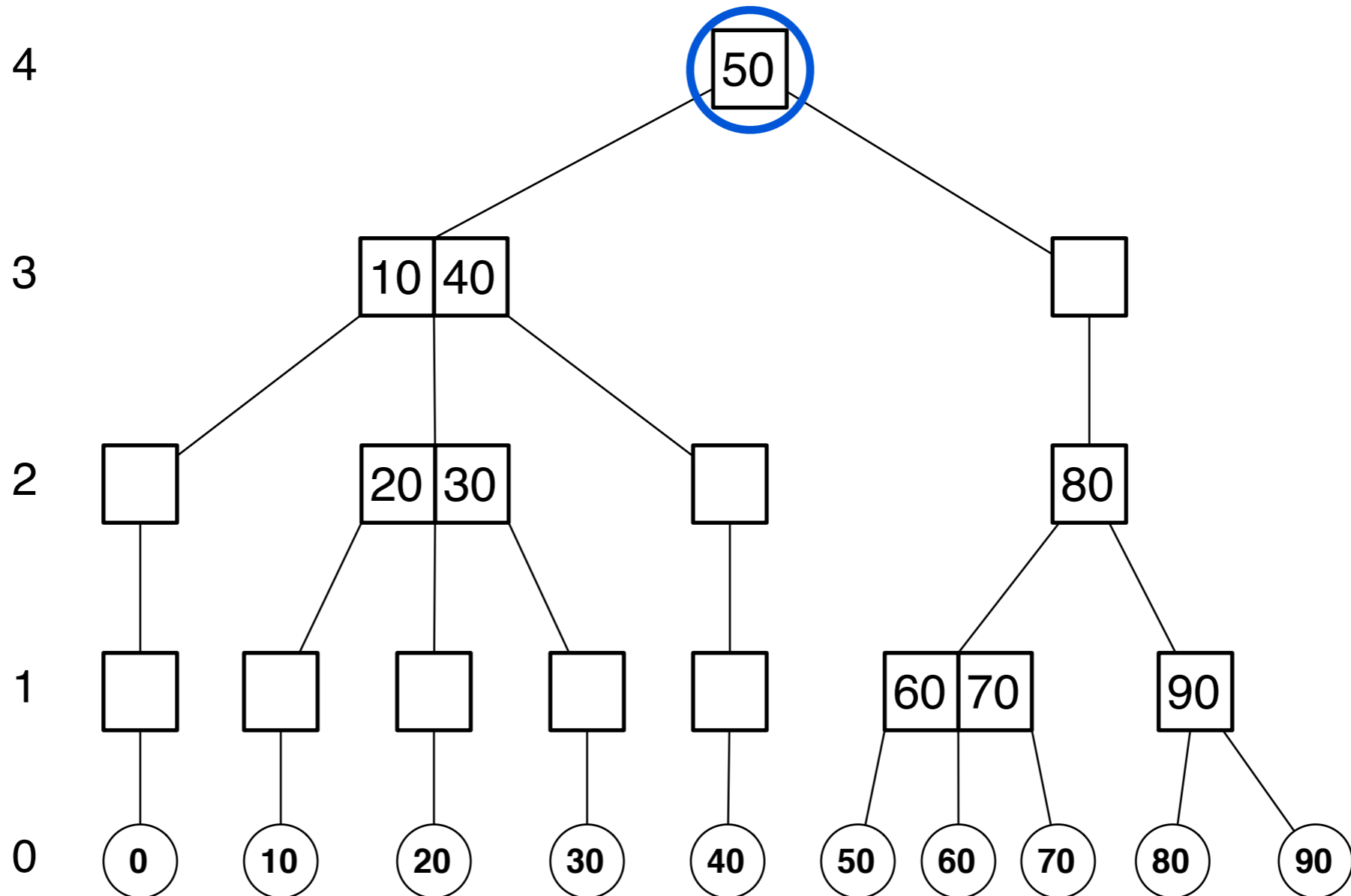

skip list

level

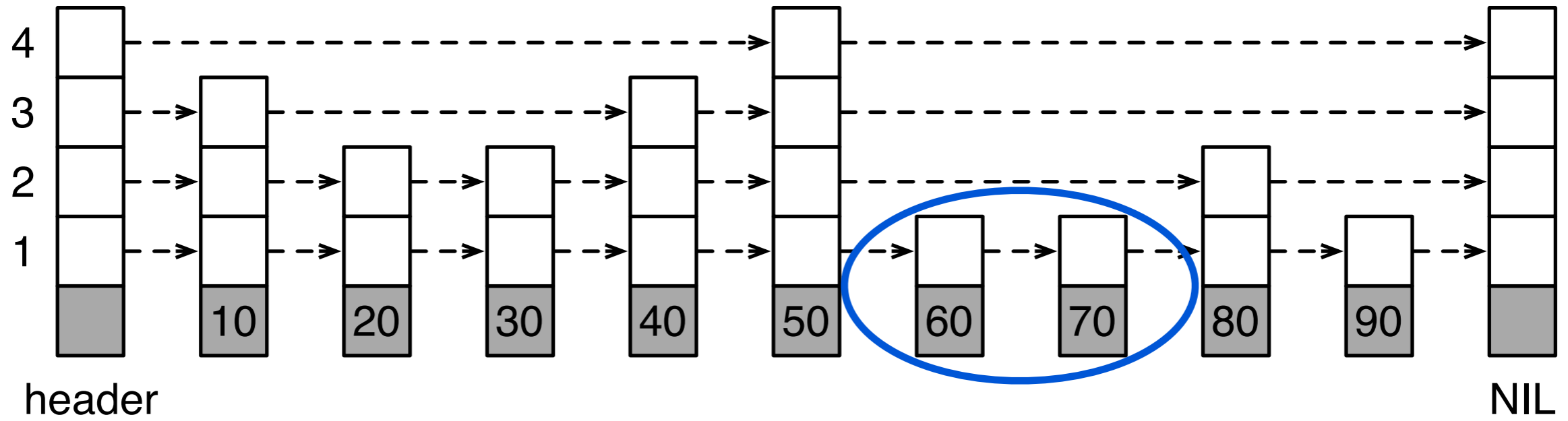

skip tree

Level

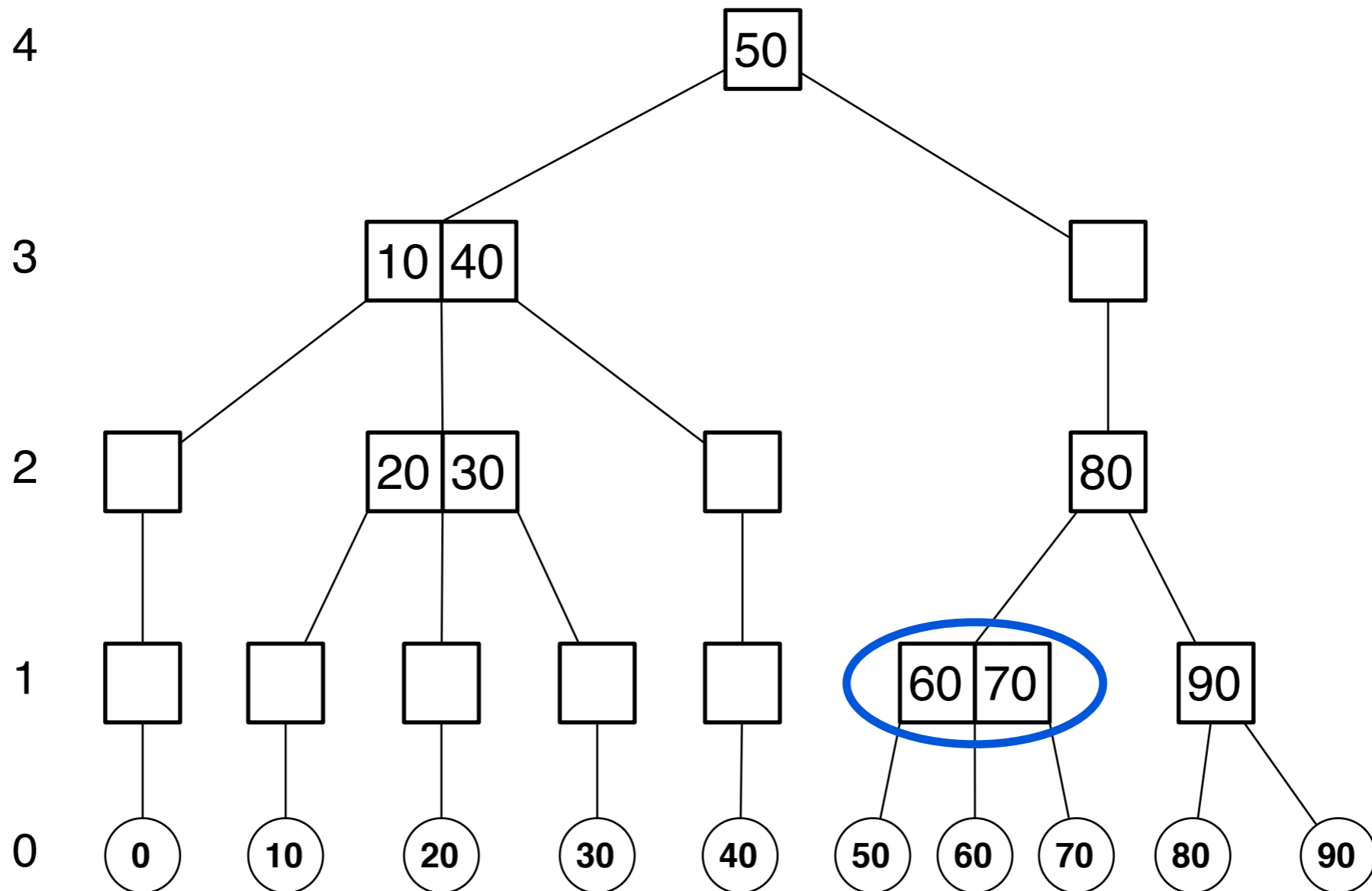

skip list

level

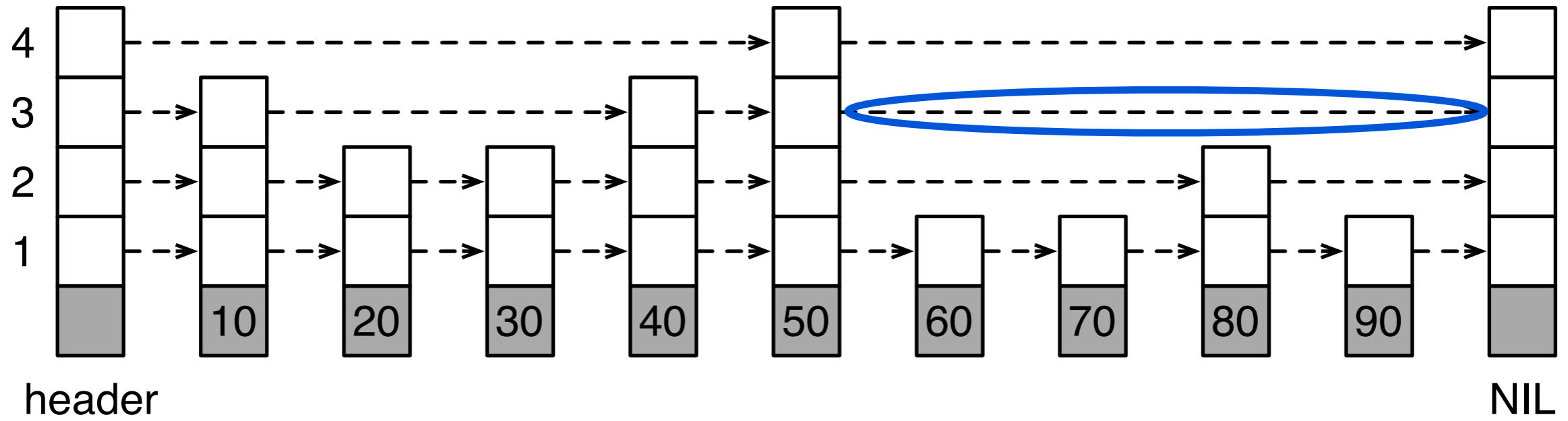

skip tree

Level

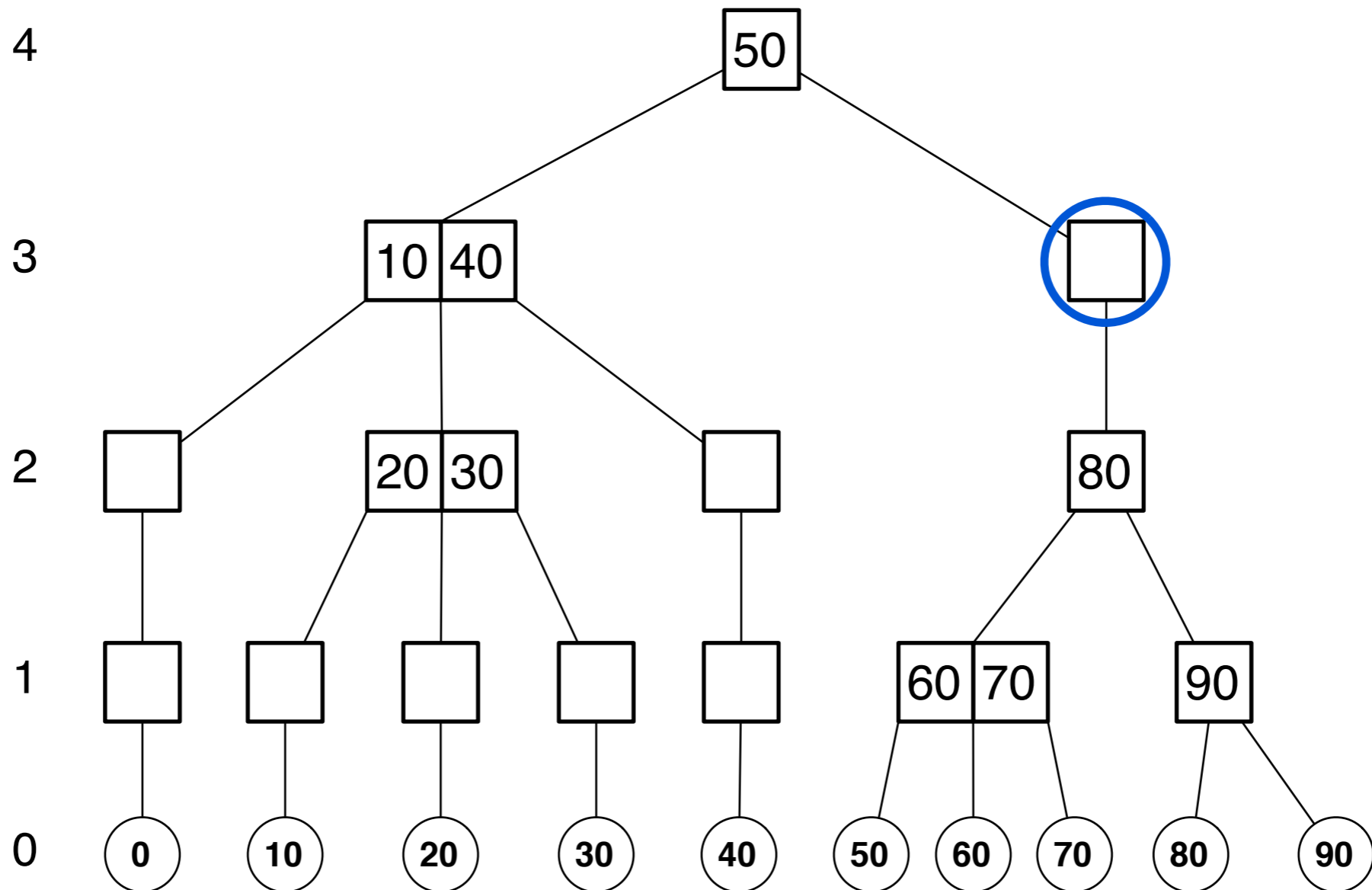

skip list

level

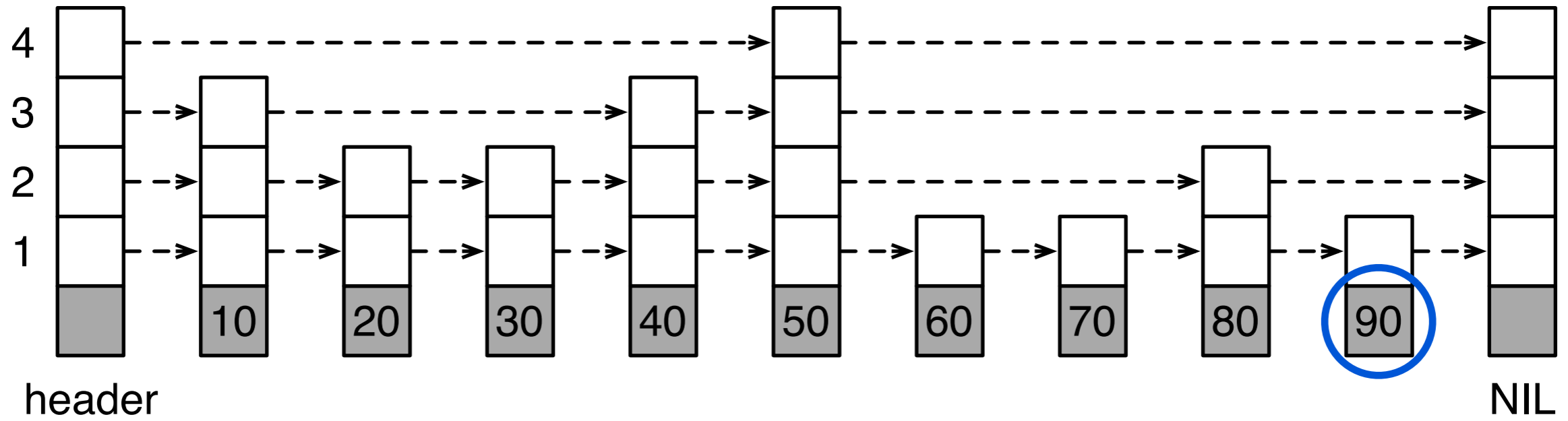

skip tree

Level

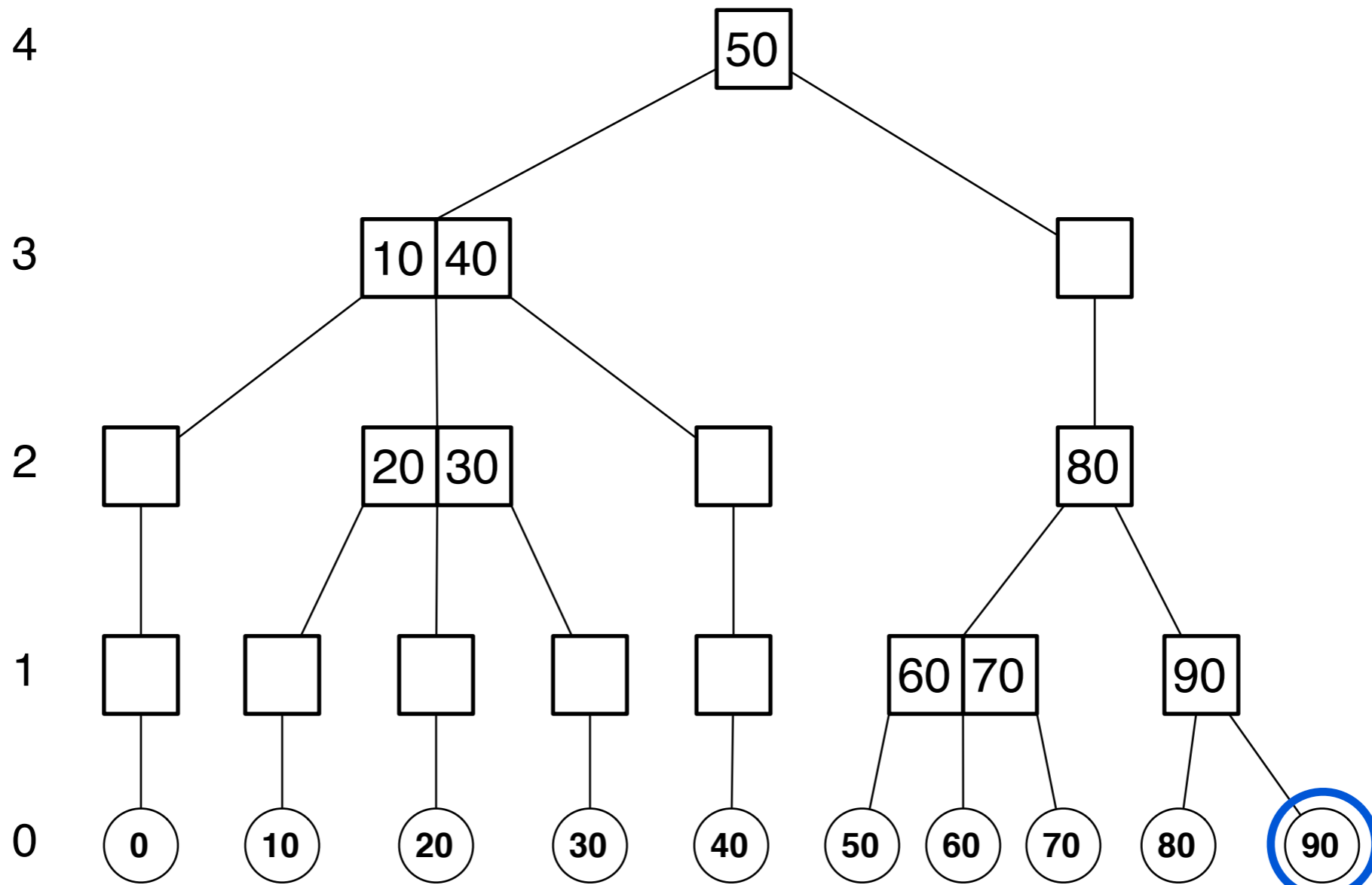

Skip Trees - Insertion

insert: 85

Level

4

50

3

10 40

2

20 30

80

1

60 70

90

0

0

10

20

30

40

50

60

70

80

90

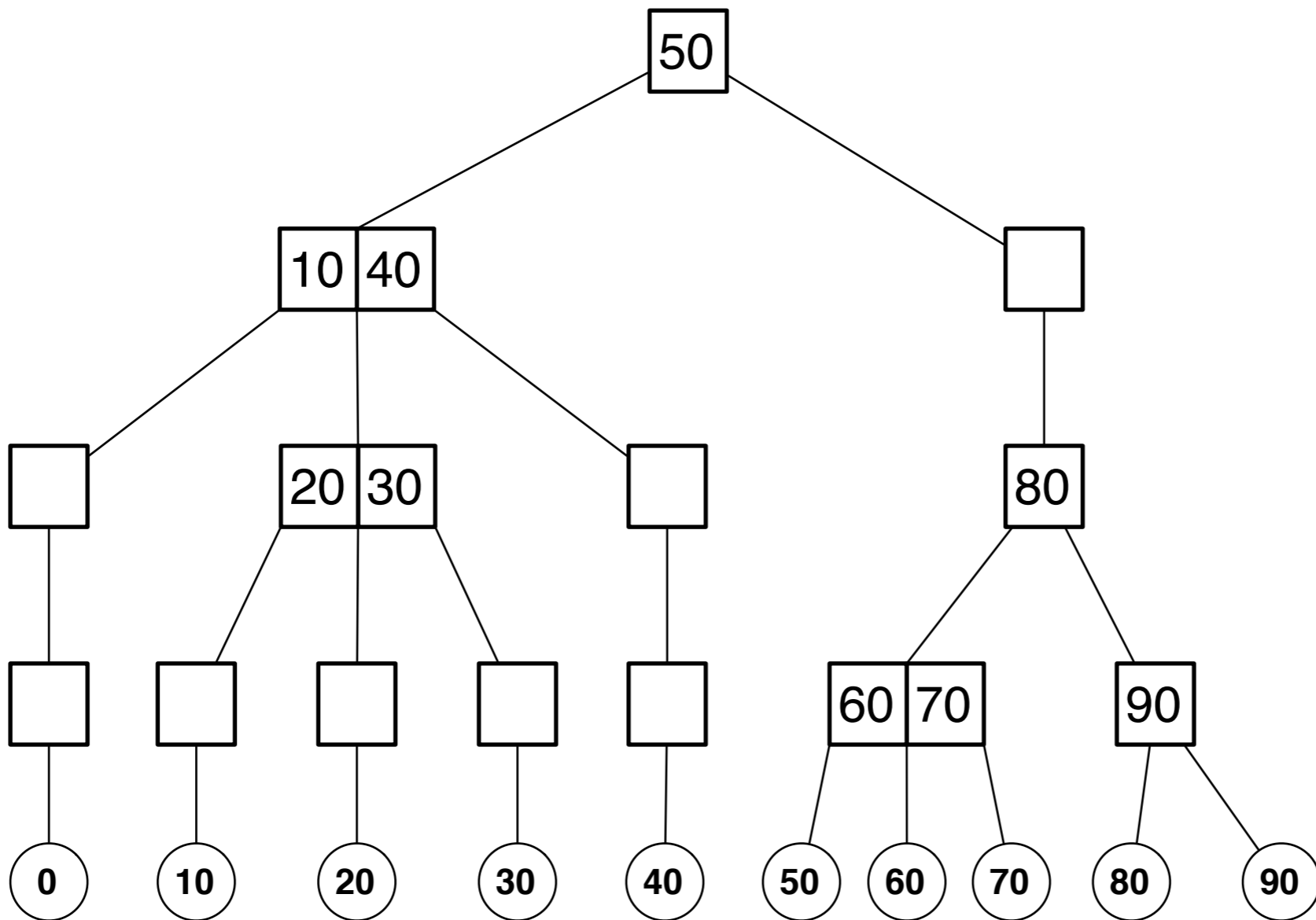

Skip Trees - Insertion

1. Percolate(1)

Level

4

50 insert: 85

3

10 40

2

20 30

80

1

60 70

90

0

0

10

20

30

40

50

60

70

80

90

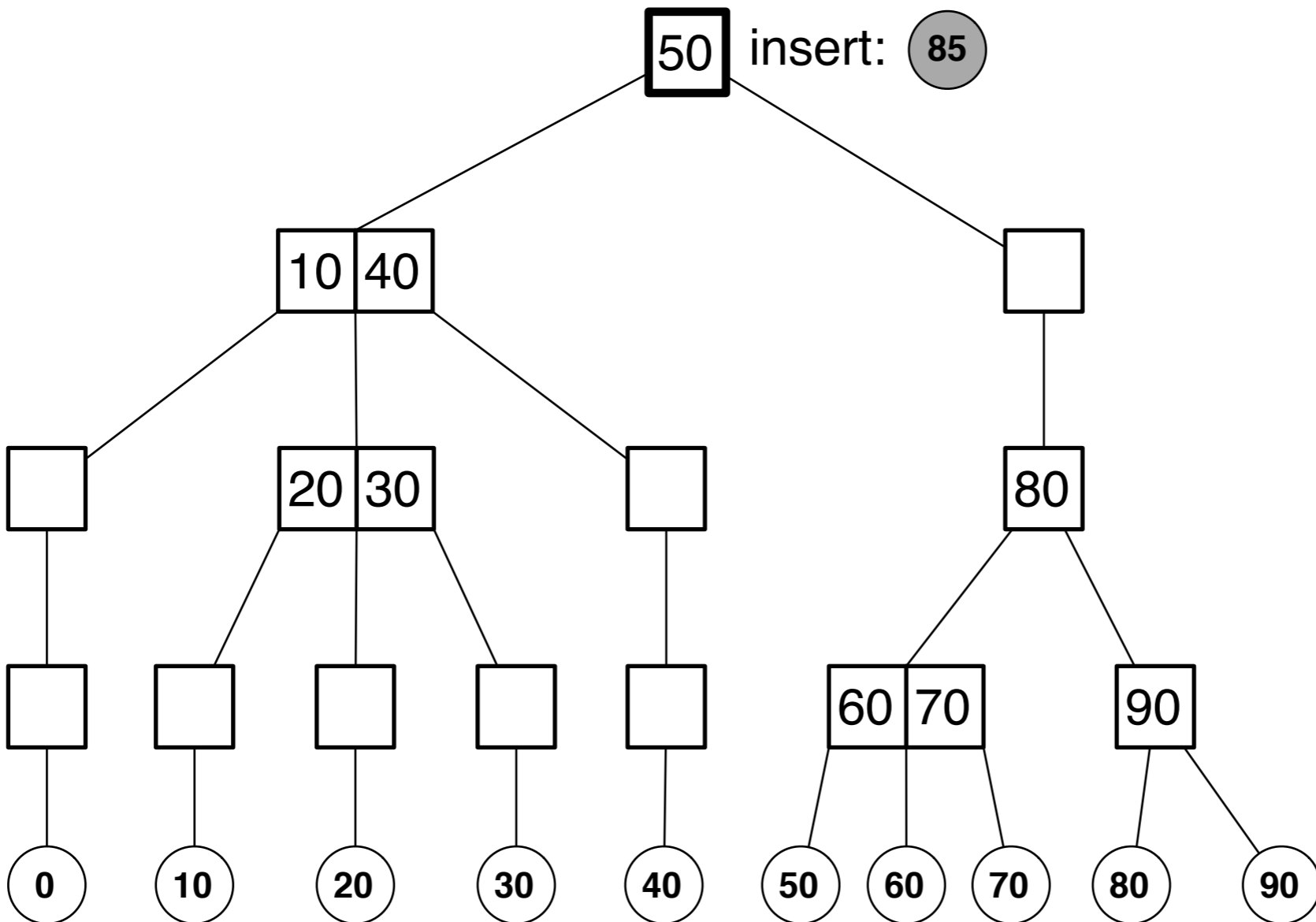

Skip Trees - Insertion

1. Percolate(2)

Level

4

3

2

1

0

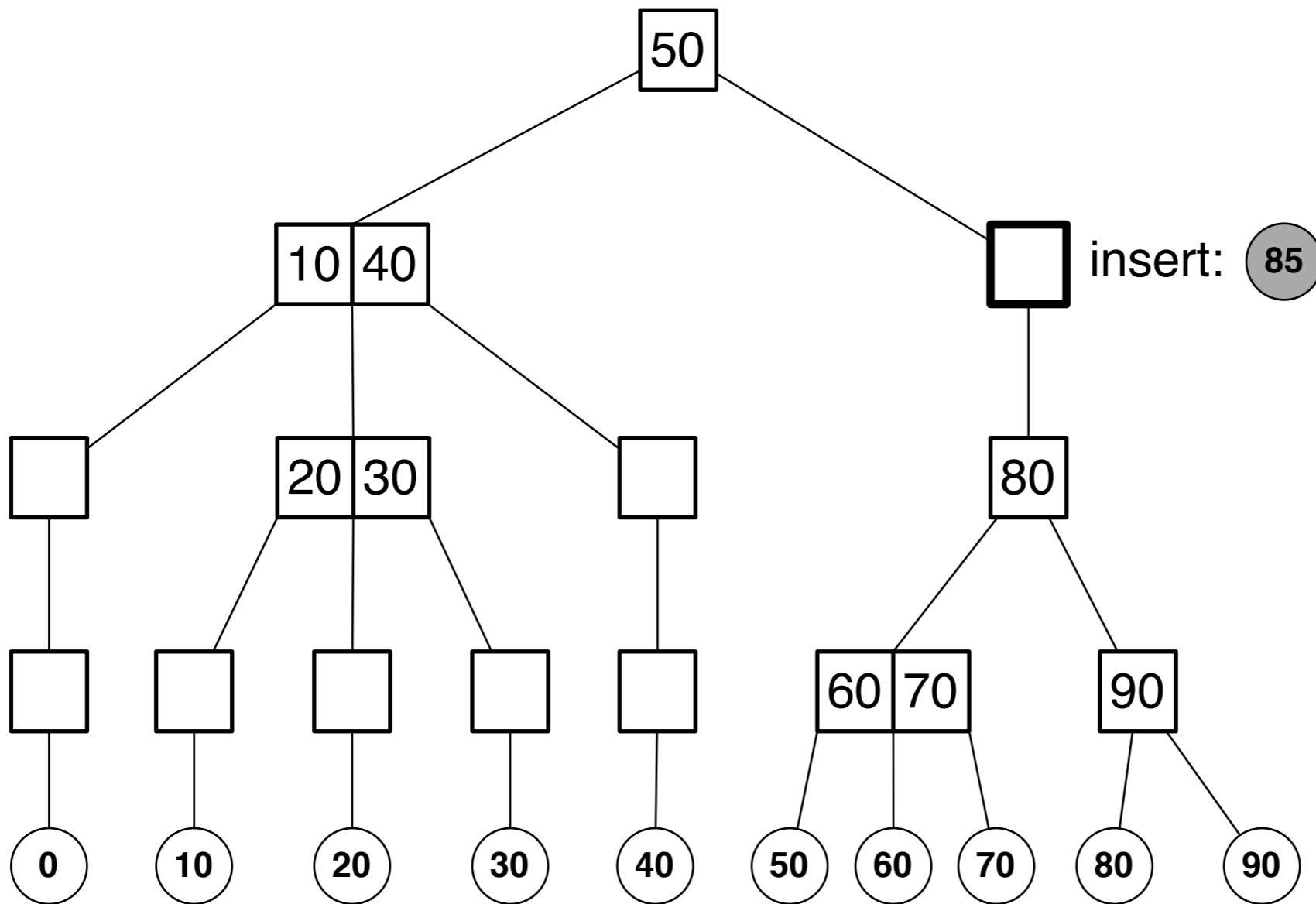

Skip Trees - Insertion

1. Percolate(3)

Level

4

3

2

1

0

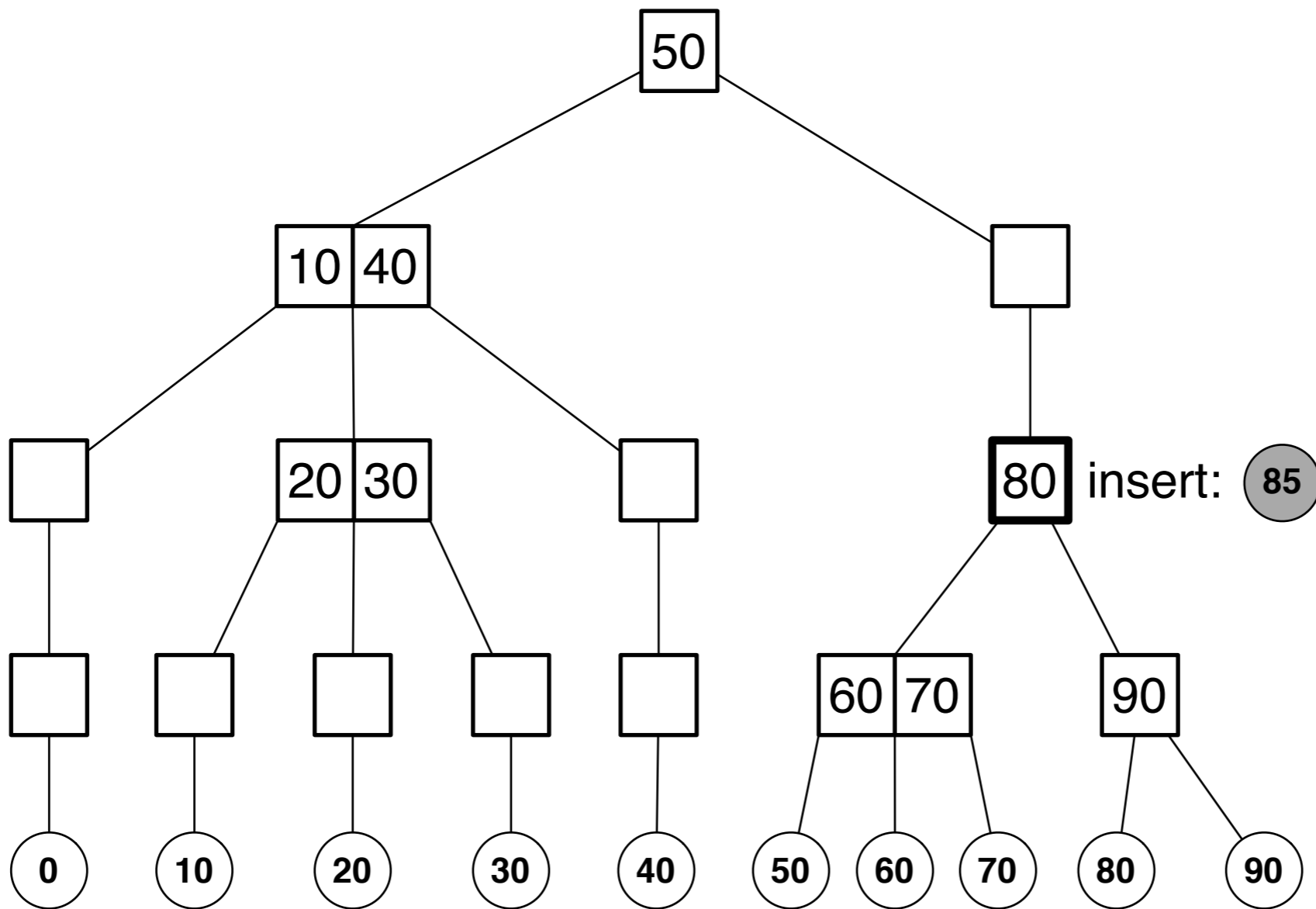

Skip Trees - Insertion

1. Percolate(4)

Level

4

3

2

1

0

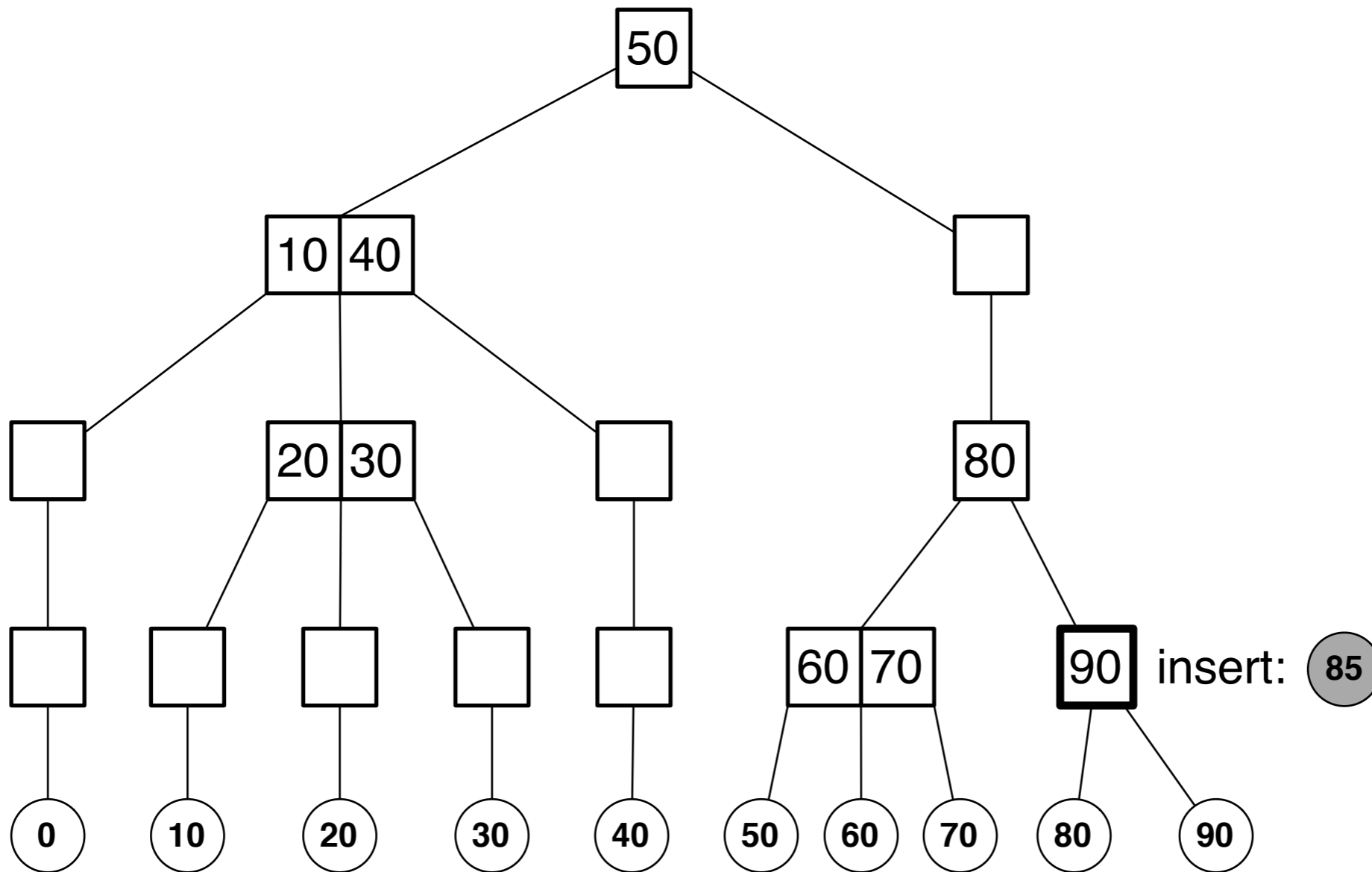

Skip Trees - Insertion

1. Percolate(5)

Level

4

3

2

1

0

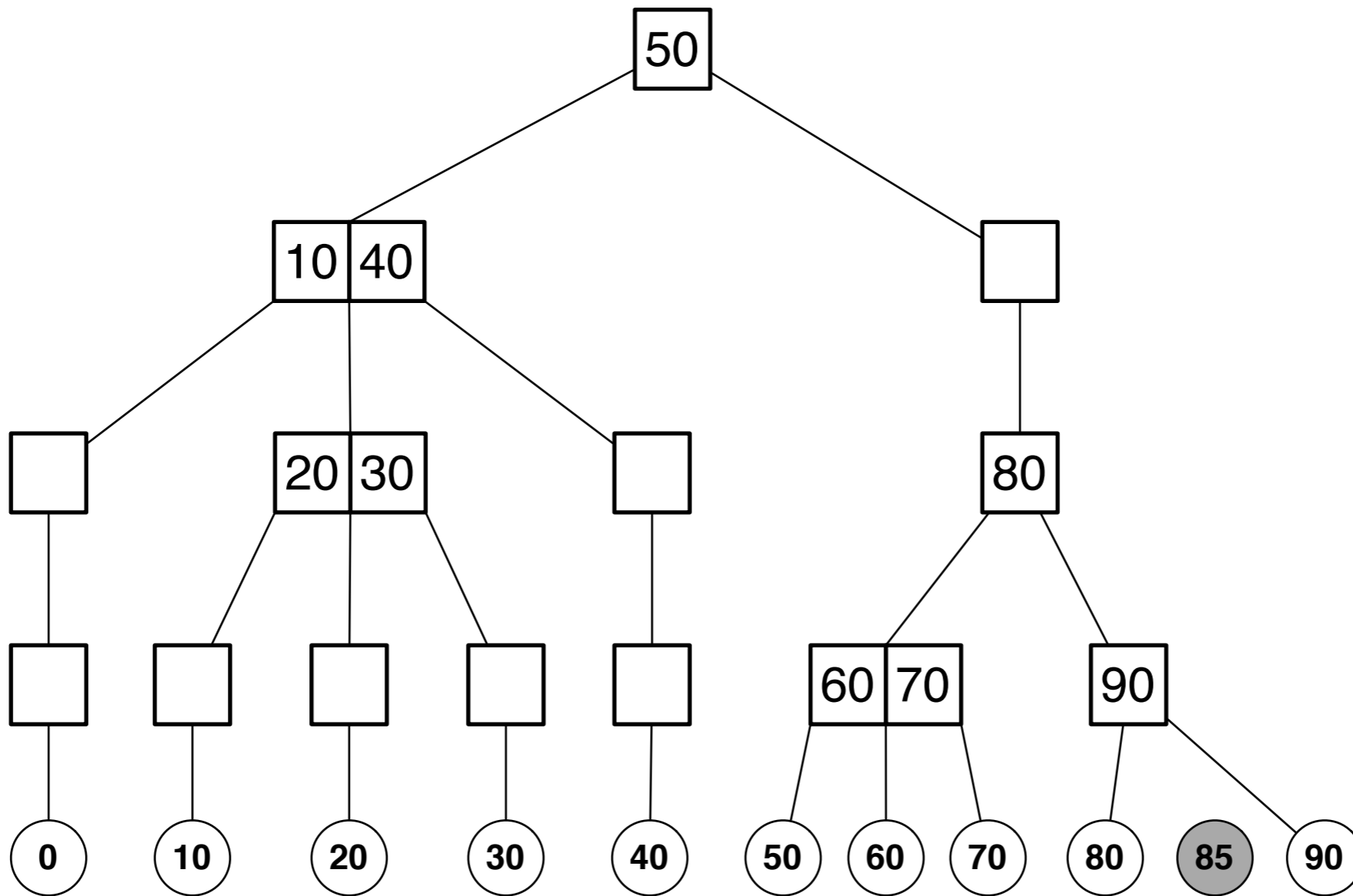

Skip Trees - Insertion

2. Attach

Level

4

3

2

1

0

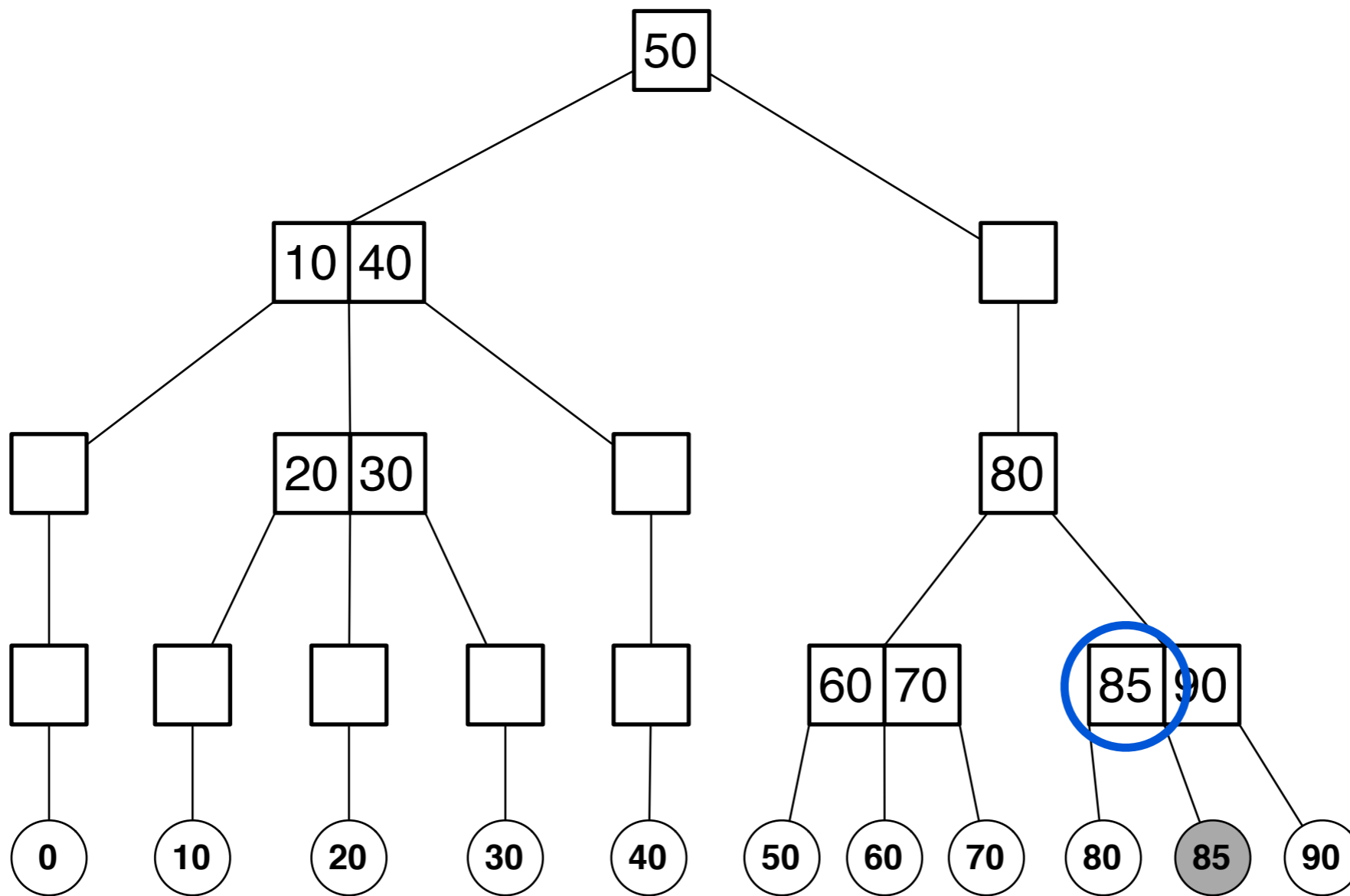

Skip Trees - Insertion

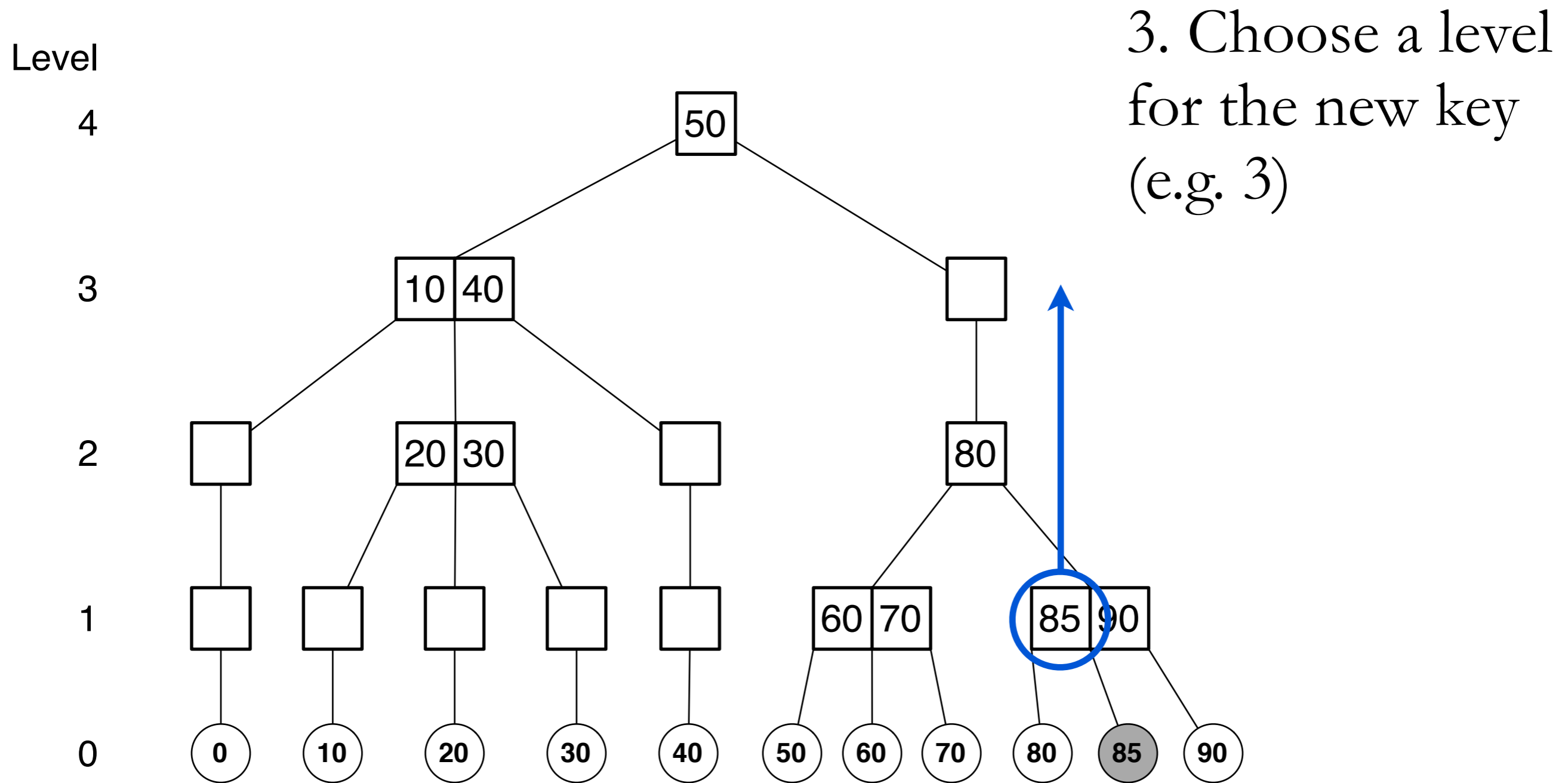

Skip Trees - Insertion

3. Split(1)

Level

4

3

2

1

0

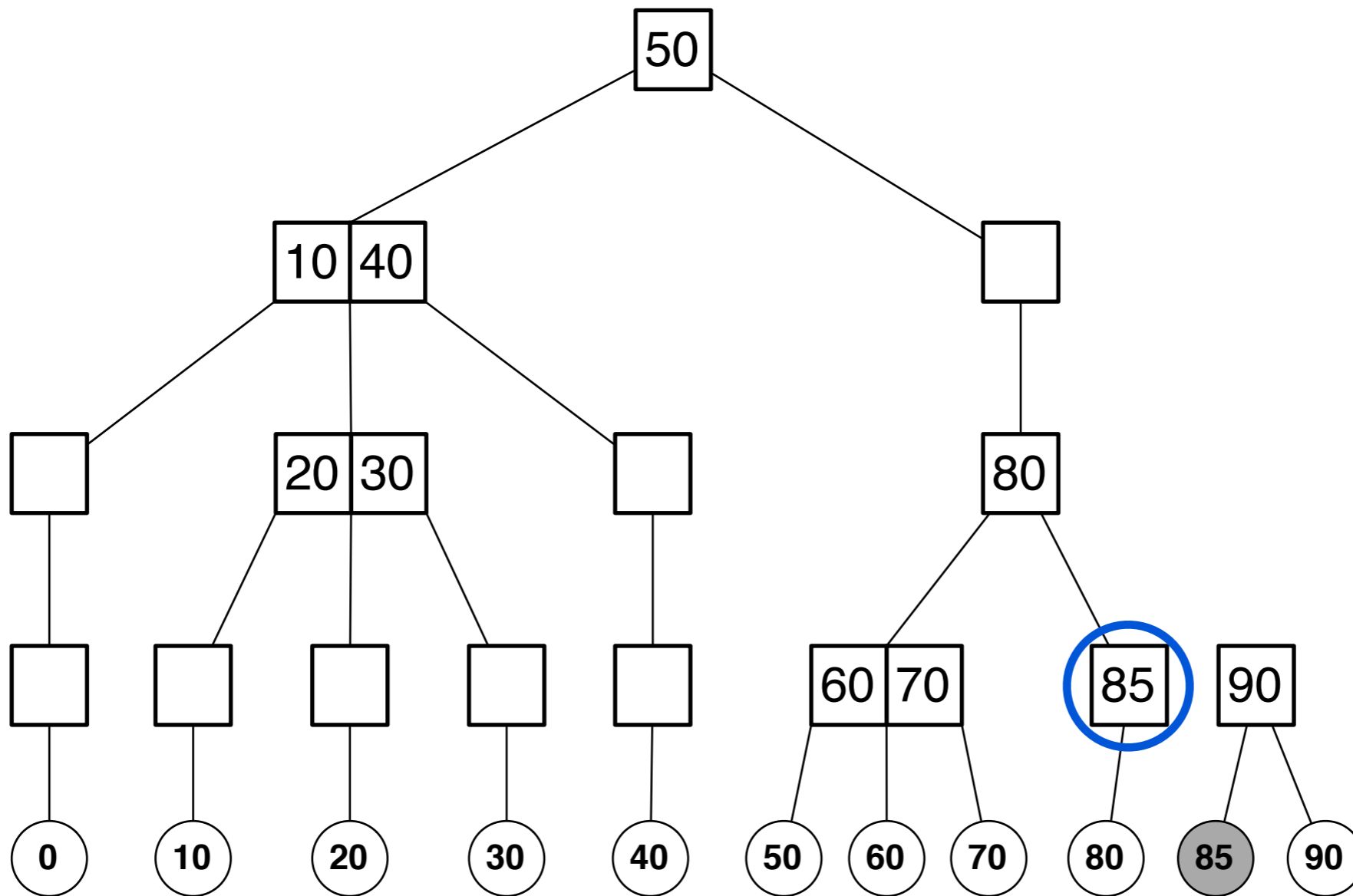

Skip Trees - Insertion

3. Split(1)

Level

4

3

2

1

0

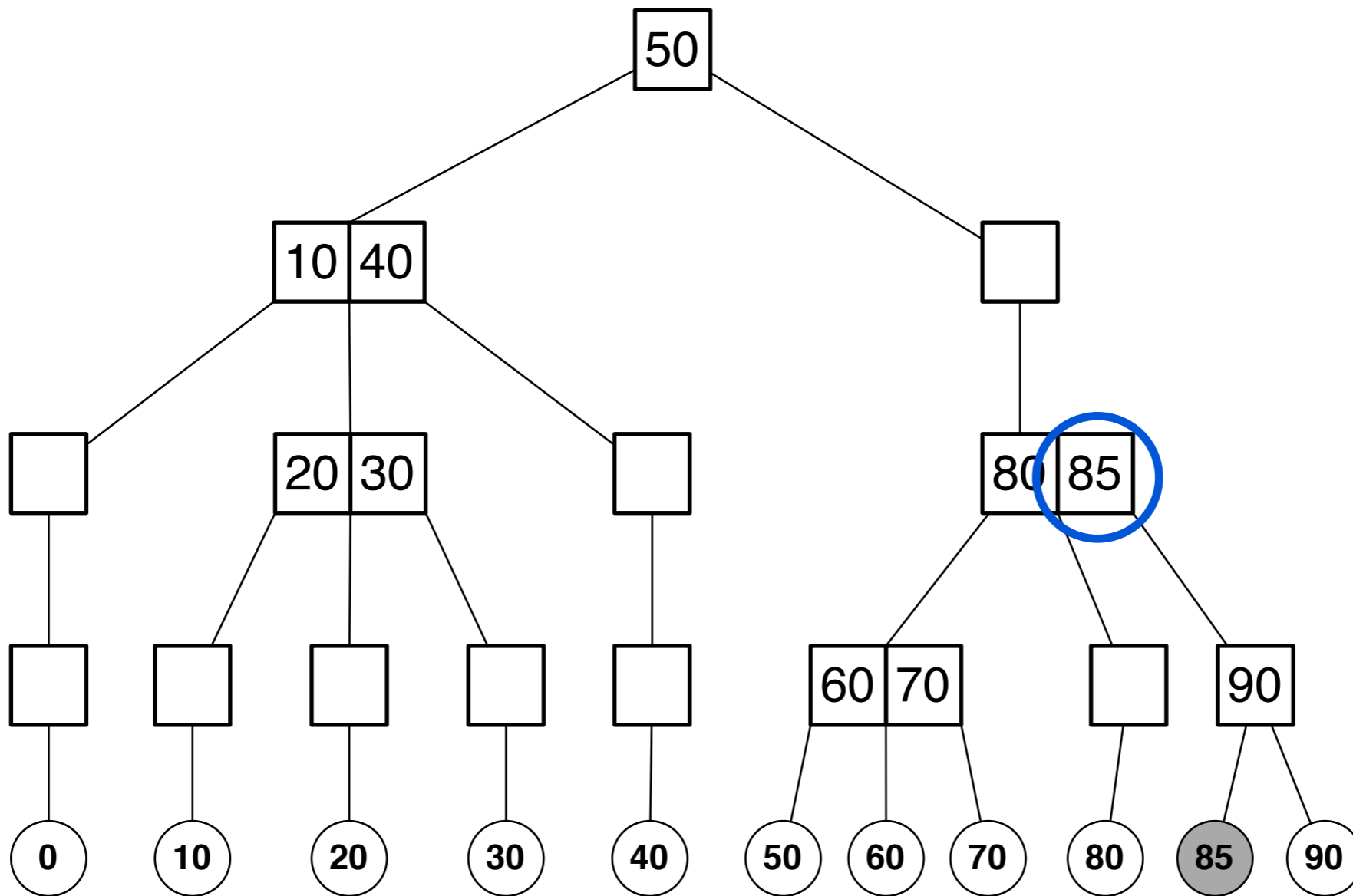

Skip Trees - Insertion

3. Split(2)

Level

4

3

2

1

0

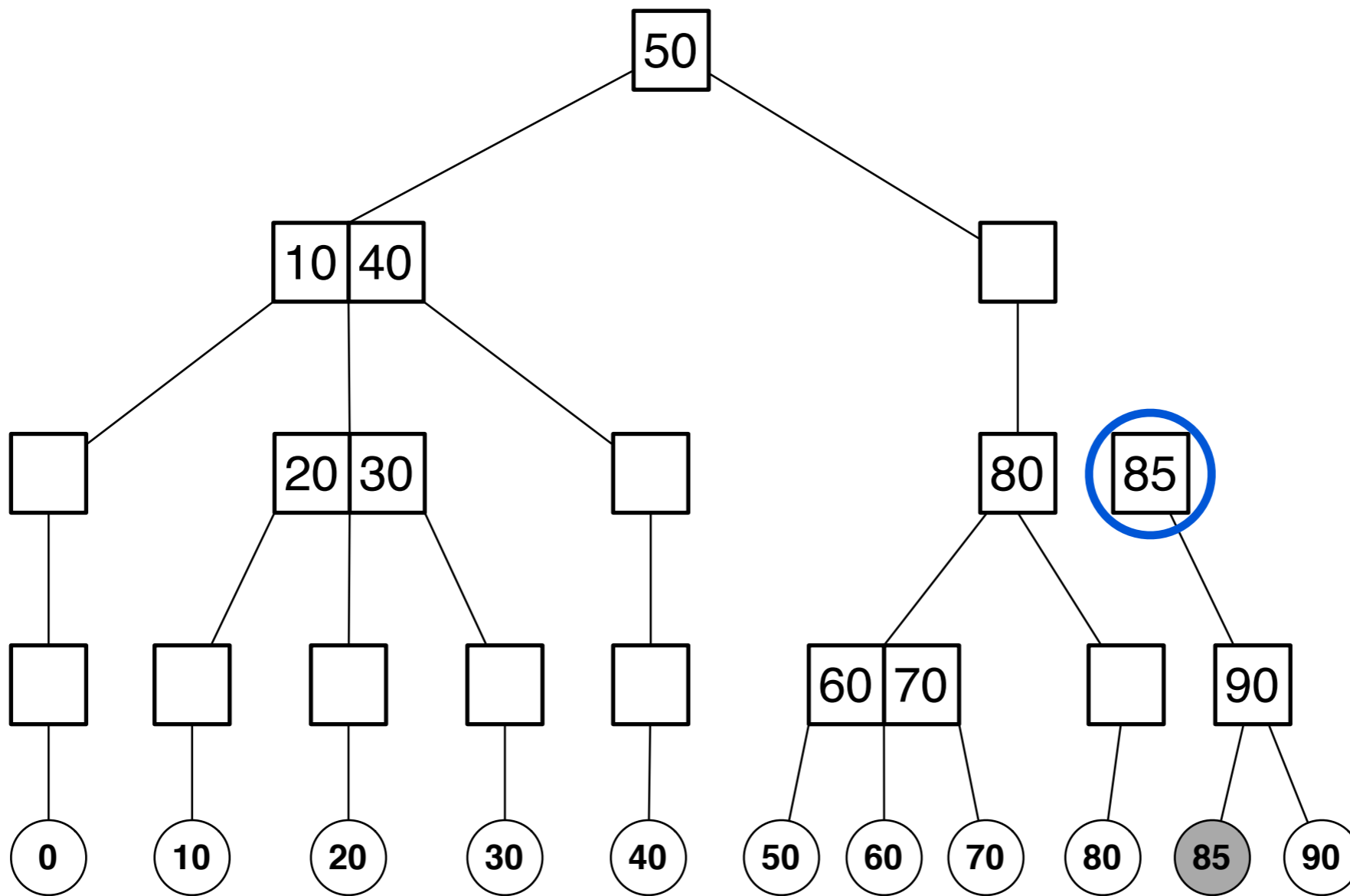

Skip Trees - Insertion

3. Split(2)

Level

4

3

2

1

0

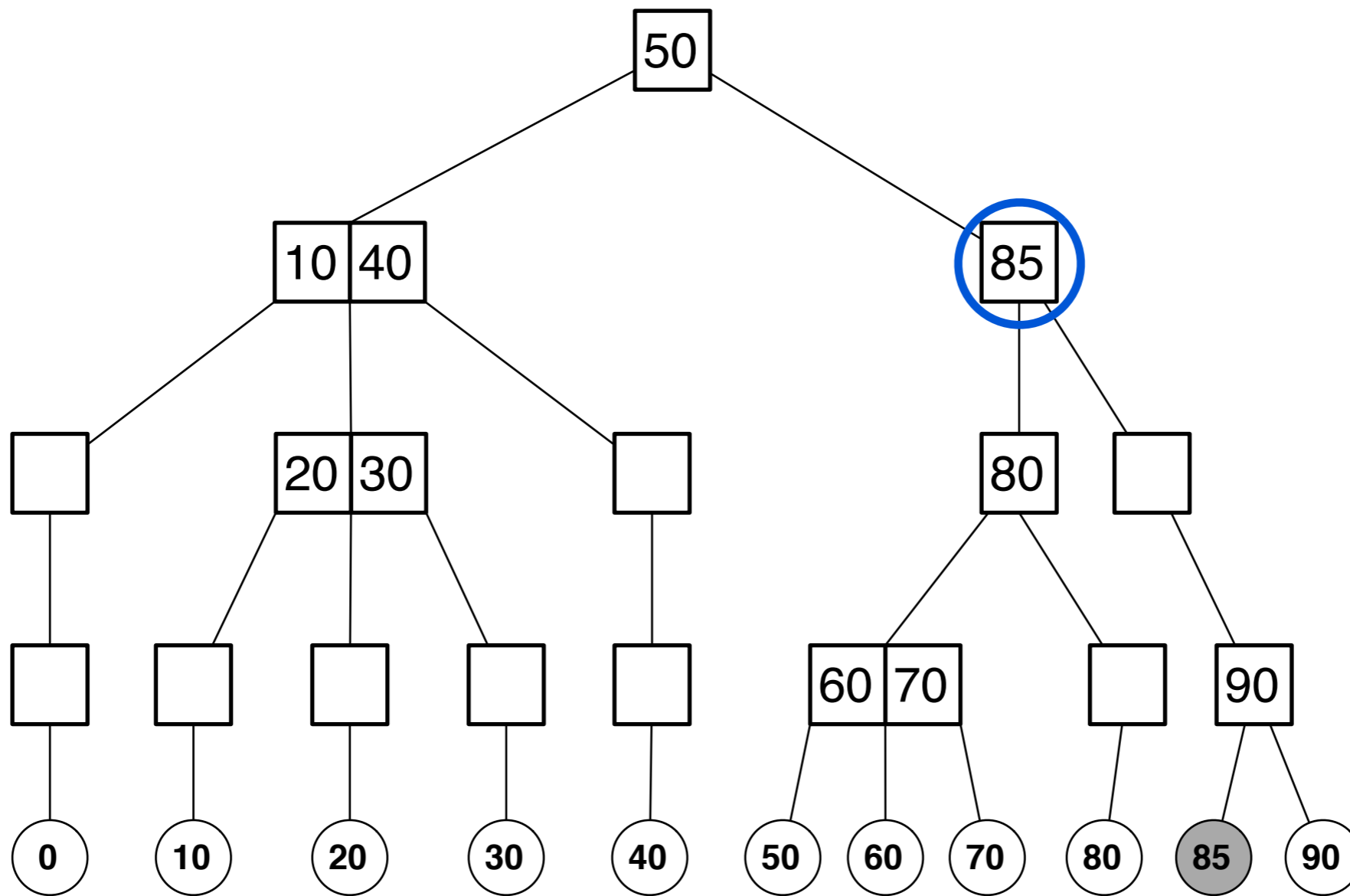

Skip Trees - Insertion

Level

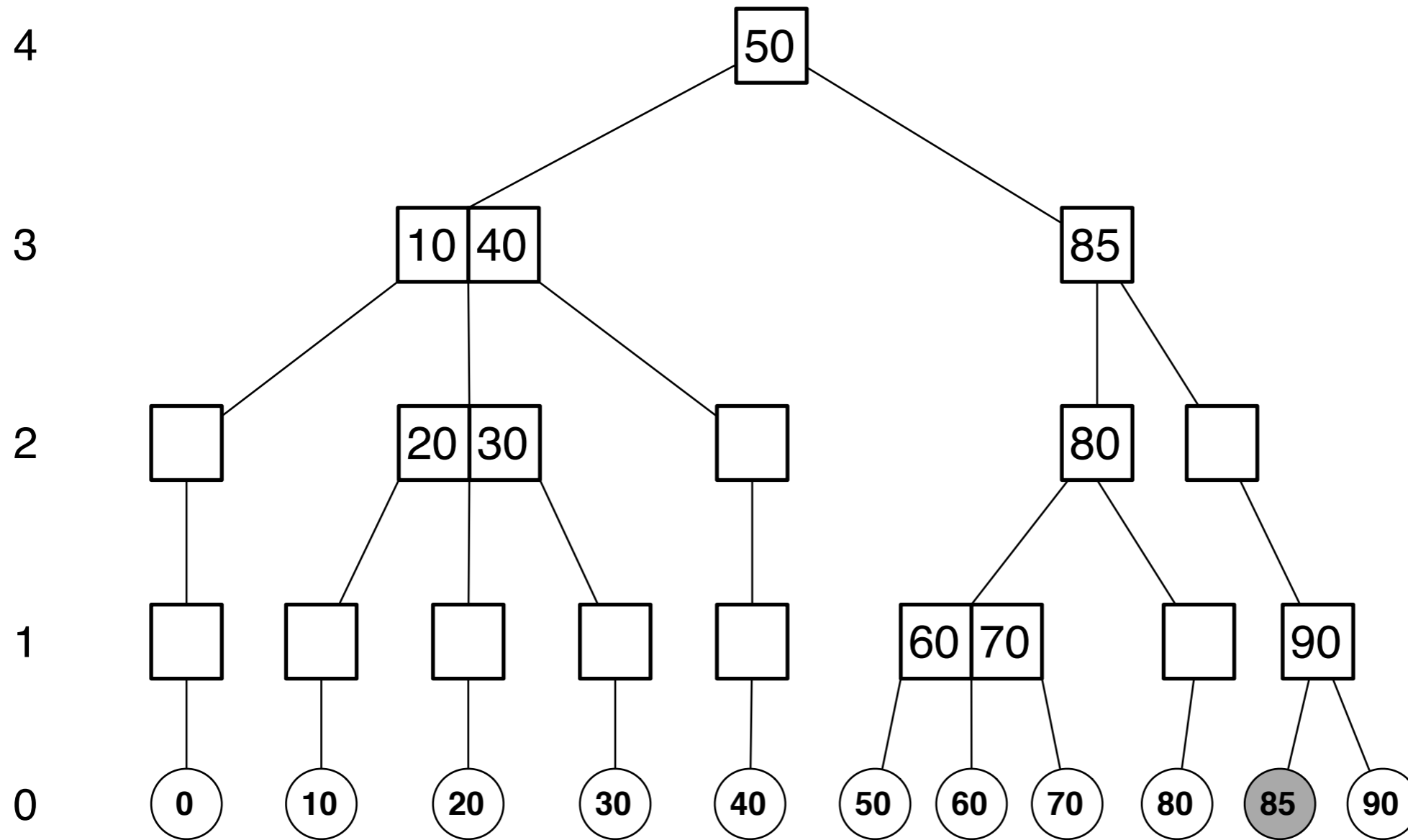

Concurrent Insertion

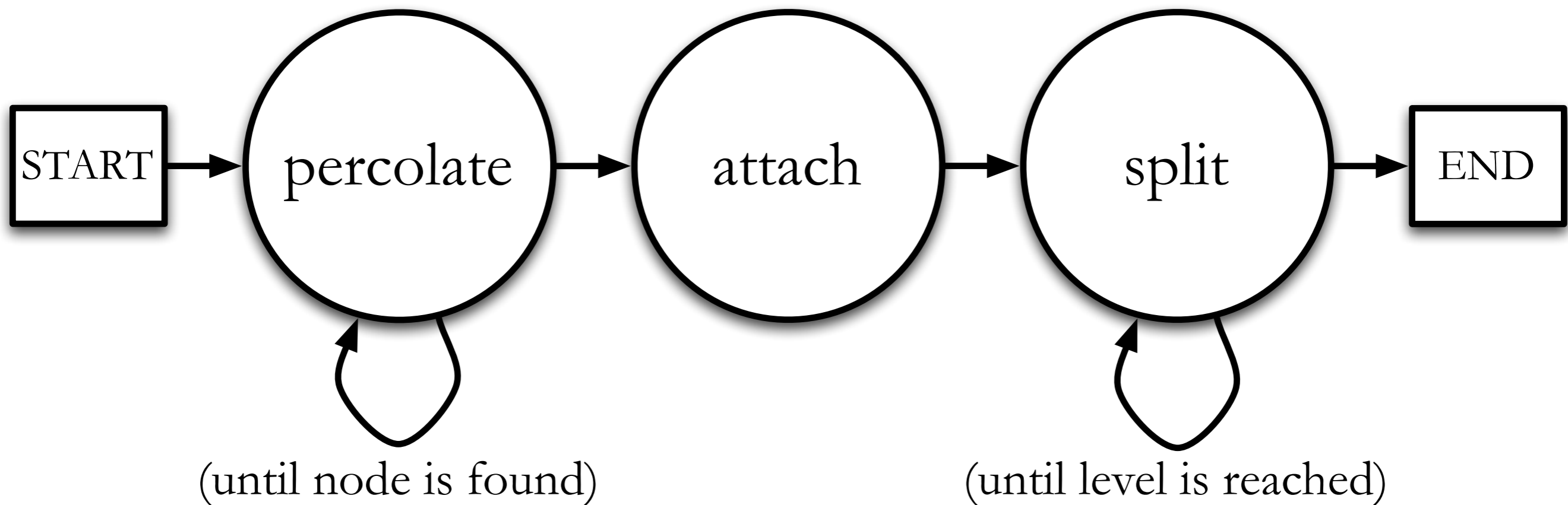

Concurrent Insertion

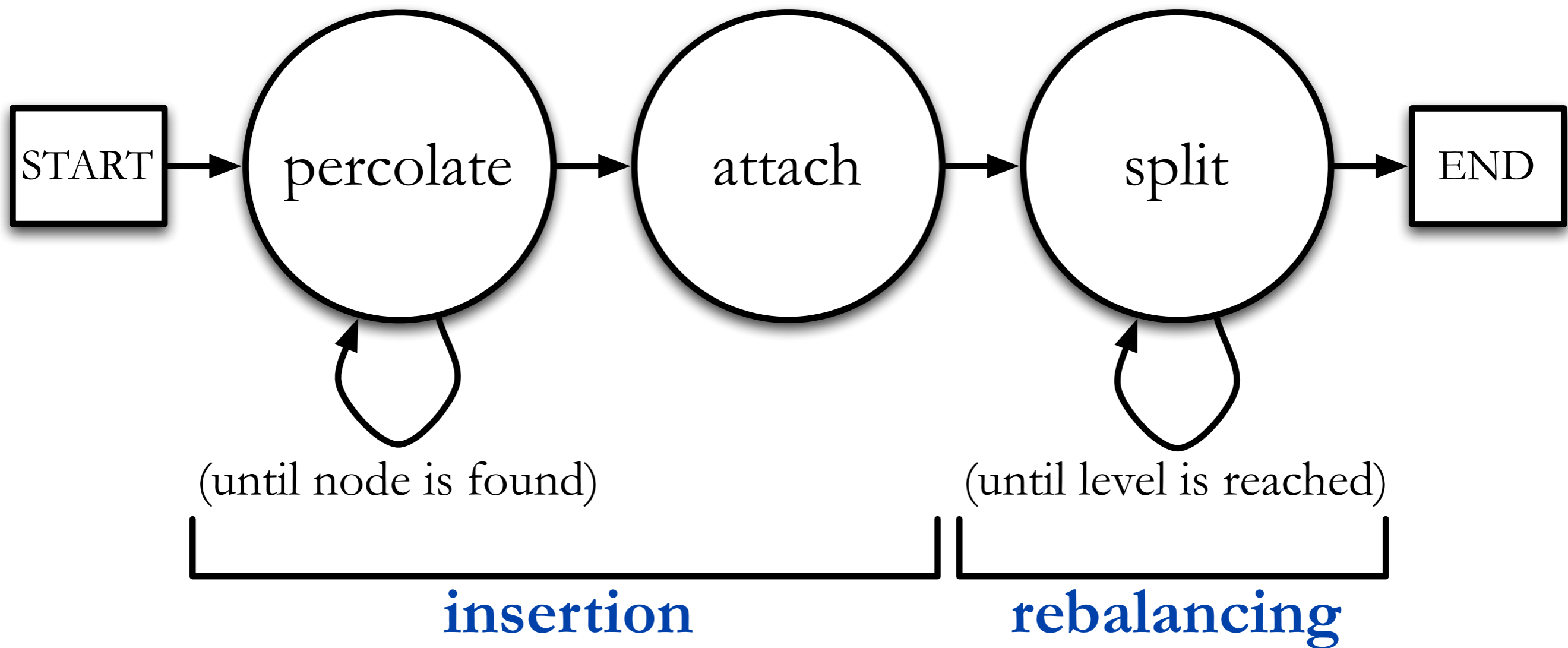

Concurrent Insertion

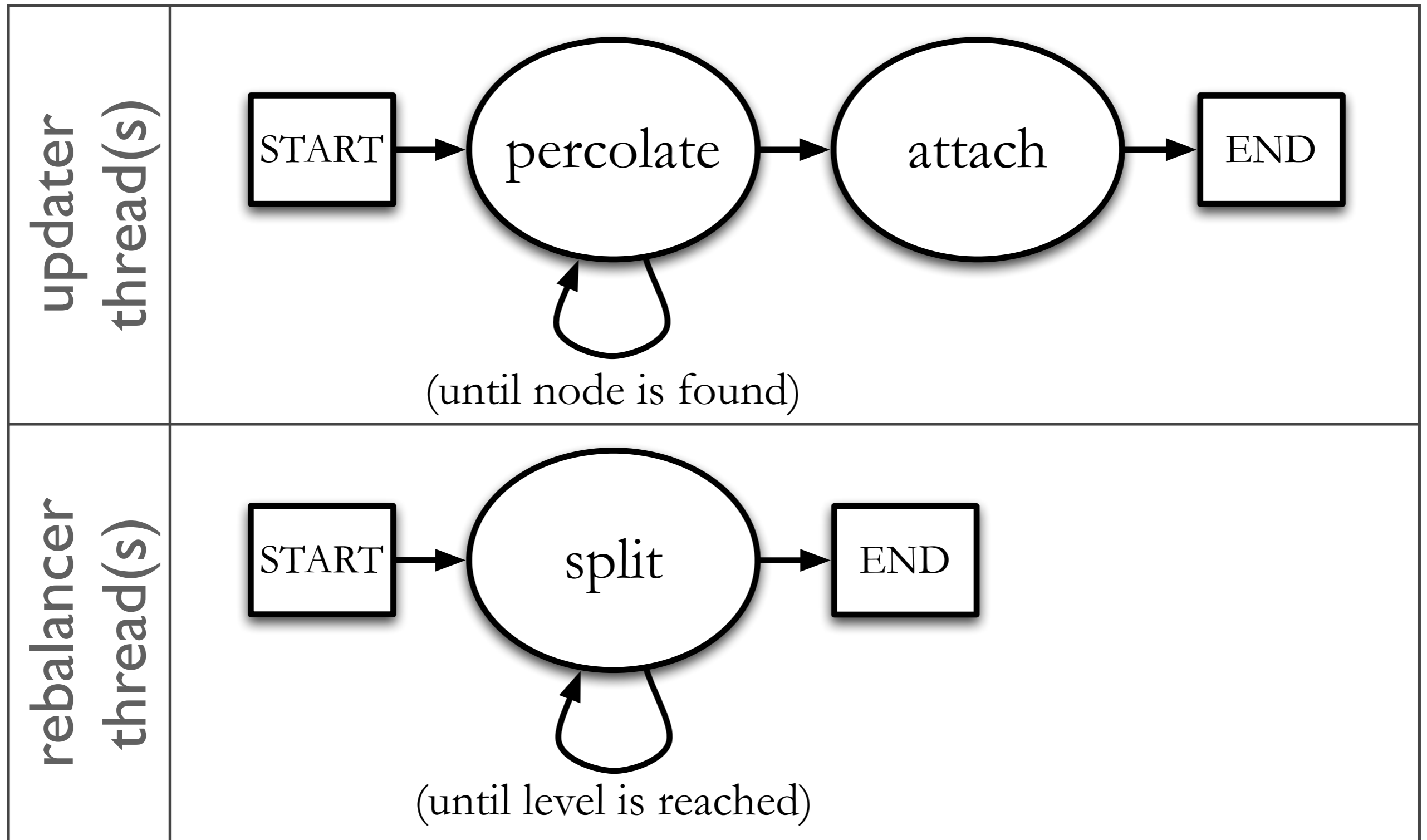

Concurrent Insertion

approach summary

- updater and rebalancer threads run in parallel
- several rebalancer threads can coexist
- percolate and split have local scope
- concurrent deletion is similar to insertion

Project Plan

- study the effects of
 - # of reader threads
 - # of updater threads
 - # of rebalancer threads

References

1. Xavier Messeguer. Skip trees, an alternative data structure to skip lists in a concurrent approach. *RAIRO Theoretical Informatics and Applications*, 31(3):251–269, May 1997.
2. Otto Nurmi and Eljas Soisalon-Soininen. Chromatic binary search trees: a structure for concurrent rebalancing. *Acta Informatica*, 31(6):547–557, September 1996.
3. William Pugh. Skip lists: A probabilistic alternative to balanced trees. *Communications of the ACM*, 33(6):668–676, June 1990.