

EECS 3221
Operating System Fundamentals

No.8

Memory Management (1)

Prof. Hui Jiang

*Dept of Electrical Engineering and Computer
Science, York University*

Memory Management

- A program usually resides on a disc as a binary executable file.
- The program can be moved between disk and memory.
- Program must be brought into memory and placed within a process for it to be executed.
- In multiprogramming, we keep several programs in memory.
- Memory management strategies:
 - Contiguous Memory Allocation
 - Paging
 - Segmentation
 - Segmentation with paging
- Memory management needs hardware support – MMU.

CPU vs. memory

- Physical memory consists of a large array of words or bytes, each with its own address.
- In a typical instruction-execution cycle:
 - CPU fetches an instruction from memory according to PC .
 - The instruction is decoded.
 - CPU may fetch operands from memory according to the address in the instruction. (optional)
 - CPU execute in registers
 - CPU saves results into a memory address (optional)
- CPU generates address from program counter, program address, etc.
- CPU sends the address to a memory management unit (MMU), which is hardware to actually locate the memory at certain location.
 - Memory protection.
 - Memory mapping (address translation).

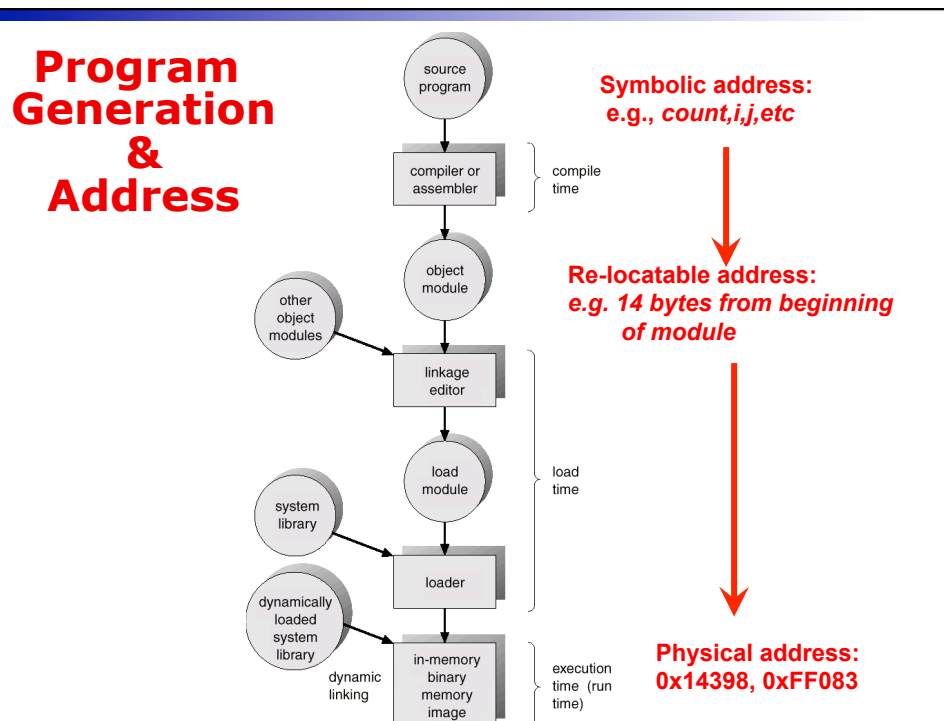

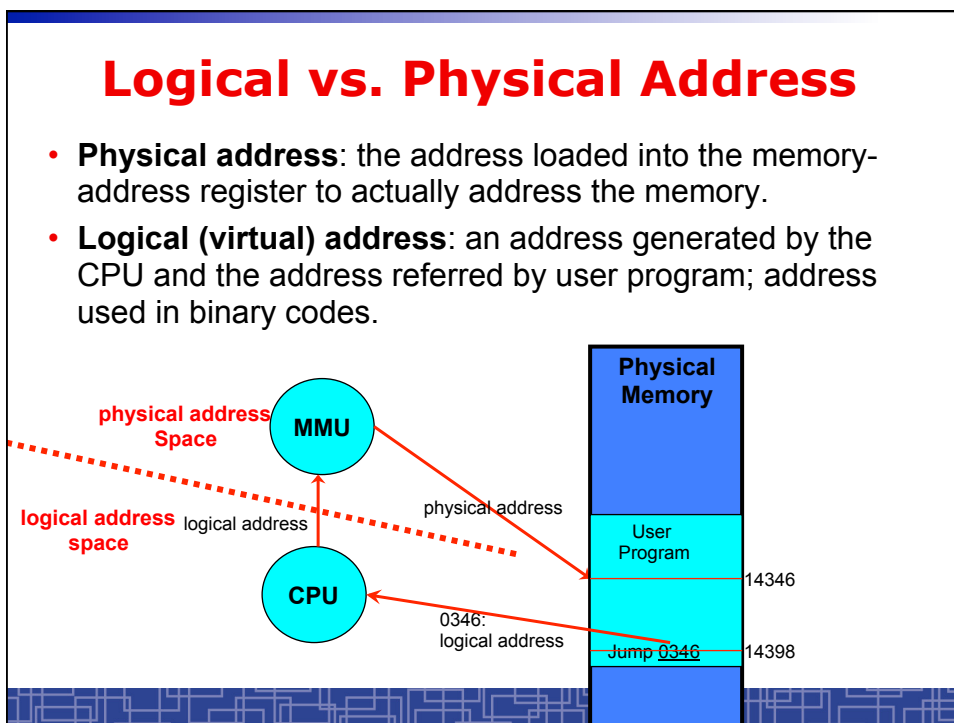
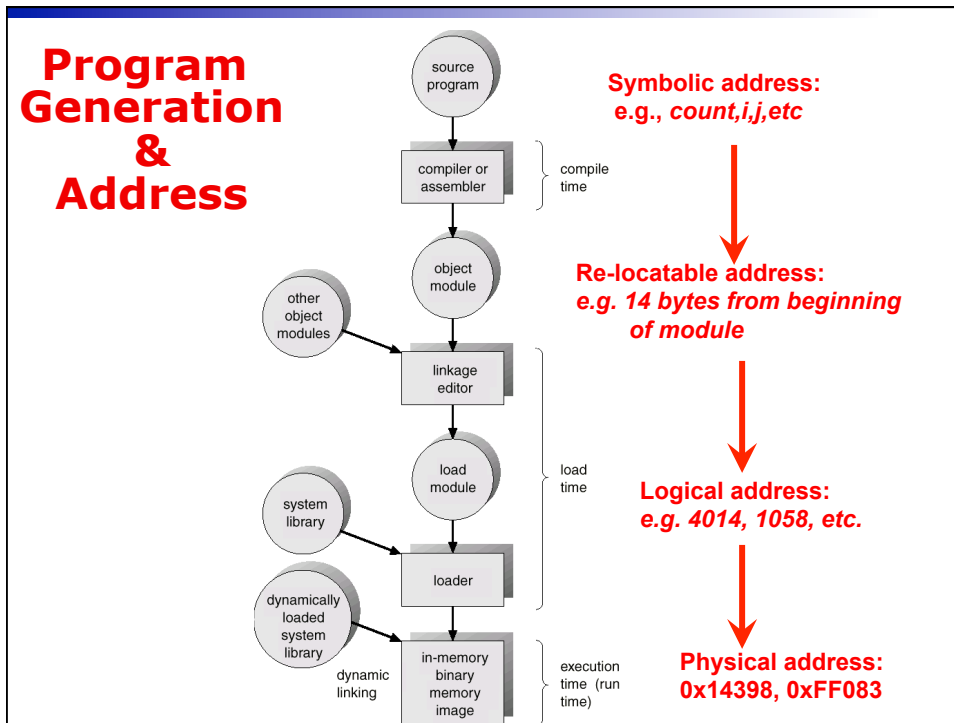

Address binding

- Address binding: binding the logical memory addresses in instructions and data to physical memory addresses.
 - In source programs: symbolic addresses (e.g., *count*, *i*, *j*, etc.)
 - A compiler will bind each symbolic address to a relocatable address (e.g. 14 bytes from the beginning of the module)
 - The linkage editor or loader will bind each relocatable address to a logical address (e.g., 4014)
 - In run-time, MMU will bind each logical address to a physical address (e.g., 074014)
 - The final physical address is used to locate memory.
- Allow a user program to be loaded in any part of the physical memory → address binding in run-time
 - completely separate physical address from logical address

Memory-Management Unit (MMU)

- MMU: maps logical address to physical address.
- The user program deals with *logical* addresses; it never sees the *real* physical addresses.
- A simple MMU scheme, the value in the relocation register is added to every address generated by a user process at the time it is sent to memory.

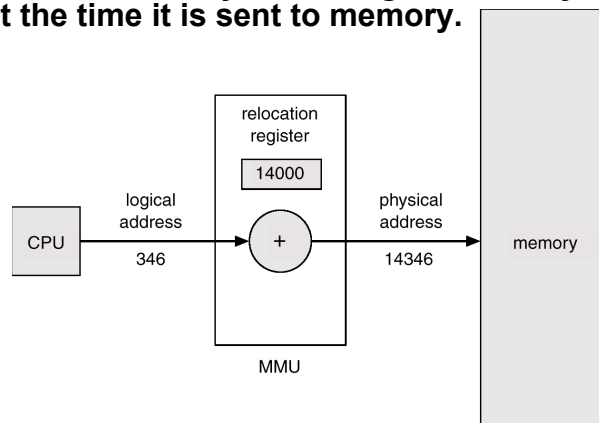

Logical vs. Physical address (2)

- Separating logical address from physical address:
 - Requires hardware support : MMI does address mapping dynamically.
- Why separating logical address from physical address?
 - Easier for compiler
 - More benefits to OS memory management
 - Consider two old methods ...

Address Binding: compile-time

- In compiling, physical address is generated for every instruction.
- The compiler has to know where the process will reside in memory.
- The code can not change location in memory unless it is re-compiled.
- No separation of logical and physical address spaces.
- Example: .COM format in MS-DOS.
 - Not a choice for a multiprogramming system.

Address Binding: load-time

- The compiler generate re-locatable code.
- When OS loading code to memory, physical address is generated for every instruction in the program.
- The process can be loaded into different memory locations.
- But once loaded, it can not move during execution.
- Loading a program is slow.

Benefits to separate LA from PA

- **Easier for compiler:**
 - Generate binary codes in separate logical spaces.
 - All instructions use LA.
- **Maximum flexibility for OS to manage memory:**
 - Program loading is fast, just direct copy.
 - The same binary code can be loaded anywhere in memory.
 - A loaded program can be re-located in memory.
- **Need hardware MMU support.**

Memory Management Approaches

- Contiguous Memory Allocation
- Paging
- Segmentation
- Segmentation with paging

Contiguous Memory Allocation

- Every process is allocated to a single contiguous section of physical memory.

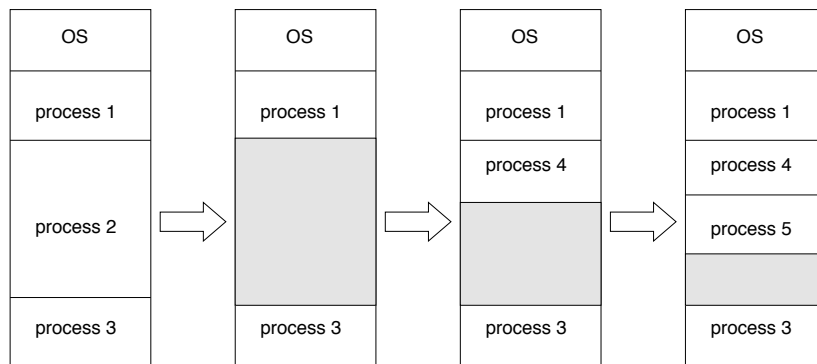

Memory Management Unit (MMU)

- Two registers:
 - Limit register: the range of logical address
 - Relocation register: starting position of physical memory
- In context switch, the dispatcher load both registers with correct values.
- Every memory access is checked by MMU hardware as:

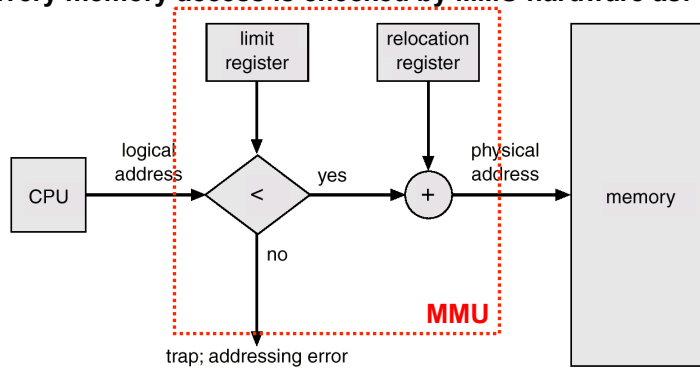

Free Memory Management

- OS must keep the information on which parts of memory are available and which are occupied.
 - allocated partitions
 - free partitions (holes)
- *Hole*: a block of free memory.
 - holes of various size are scattered throughout memory
- When a process arrives, it is allocated memory from a hole large enough to accommodate it.
- Use linked lists:

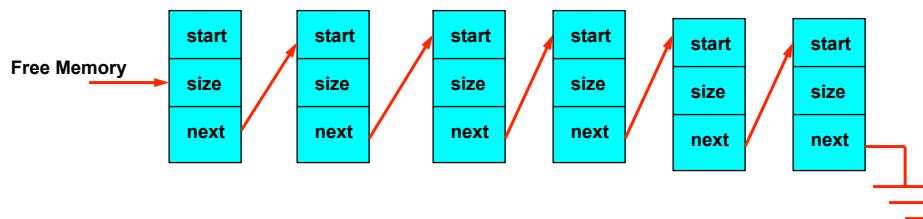

Dynamic Storage-Allocation Problem

How to satisfy a request of size n from a list of free holes that have various size.

- **First-fit:** Allocate the *first* hole that is big enough.
 - **Best-fit:** Allocate the *smallest* hole that is big enough; must search entire list, unless ordered by size. Produces the smallest leftover hole.
 - **Worst-fit:** Allocate the *largest* hole; must also search entire list. Produces the largest leftover hole.
1. First-fit and best-fit are better than worst-fit in terms of speed and memory utilization.
 2. First-fit is faster than best-fit.

Contiguous Memory Allocation: External Fragmentation

- External fragmentation – total memory space exists to satisfy a request, but it is not contiguous.
- Contiguous memory allocation suffers serious external fragmentation; Free memory is quickly broken into little pieces.
 - *50-percent rule* for first fit (1/3 is wasted).
- Reduce external fragmentation by compaction:
 - Shuffle memory contents to place all free memory together in one large block.
 - Compaction is possible *only* if relocation is dynamic, and is done at execution time.
 - Compaction is very costly.
- Reduce external fragmentation by better memory management methods:
 - Paging.
 - Segmentation.

Contiguous Memory Allocation: Expanding memory

- How to allocate more memory to an existing process?
 - Move-and-Copy may be needed.
- It is difficult to share memory among different processes.